



ADVANCEMIG315C INVERTER WELDER

OPERATING INSTRUCTIONS



👉 IMPORTANT!

Read these Operating Instructions Completely before attempting to use this machine. Save this manual and keep it handy for quick reference. Pay particular attention to the safety instructions we have provided for your protection. Contact your distributor if you do not fully understand anything in this manual.



IGBT
INVERTER
TECHNOLOGY



DIRECT
CURRENT
OUTPUT



CONSTANT
CURRENT/
VOLTAGE



SPOOL GUN
CAPABLE



POWER FACTOR
CORRECTION



SPIKE/
GENERATOR
SAFE



INTELLIGENT
PROTECTION
SYSTEM



LED
SCREEN



IP23 CORROSION
& SALT SPRAY
RESISTANT



ADVANCEMIG315C

1	CONTENTS.....	2
3	KNOW YOUR MACHINE.....	8
3.1	Machine Front.....	8
3.2	Machine Side.....	8
3.3	Machine Rear.....	9
3.4	Control Panel.....	9
3.5	LCD Readout.....	10
3.6	Symbols chart.....	11
4	CONTROLS EXPLAINED.....	12
4.1	Weld Process Selection.....	12
4.1.1	MIG Process:.....	12
4.1.2	Stick:.....	12
4.2	Function Selection.....	13
4.2.1	Pre-Gas Time (MIG).....	14
4.2.2	Post-Gas Time (MIG).....	14
4.2.3	Soft-Start Adjustment (MIG).....	14
4.2.4	Burnback Adjustment (MIG).....	14
4.2.5	Spot/Stitch Weld Time (MIG).....	14
4.2.6	Stitch Weld Gap/Interval Time (MIG).....	14
4.2.7	Spool Gun On/Off (MIG).....	15
4.2.8	Hot Start Adjustment (Stick).....	15
4.2.9	Arc Force Adjustment (Stick).....	15
4.2.10	Optional VRD Function (Stick).....	15
4.3	Trigger Mode Selection.....	16
4.3.1	2T (Standard Trigger).....	16
4.3.2	4T (Latch Trigger).....	16
4.3.3	SP (Spot/Stitch).....	16
4.4	Inductance Control.....	17
4.5	Test Gas.....	17
4.6	Feed Wire / Wire Inch.....	18
4.7	Job Memory.....	18



ADVANCEMIG315C

5	POWER SUPPLY	19
5.1	Electrical Connection.....	19
5.2	Extension Leads.....	19
5.3	Generator Use	19
5.3.1	Generator Size.....	19
5.3.2	Generator Quality & Warranty Limitations	19
5.3.3	3 Golden Rules of Generator use	19
6	OPERATING ENVIRONMENT.....	20
6.1	Location.....	20
6.2	Ventilation	20
7	BASIC OPERATION	21
7.1	MIG Welding.....	21
7.1.2	Fitting Wire Spool – 200mm Diameter (5kg).....	21
7.1.3	Loading Wire Feeder	22
7.1.4	Gas MIG Welding Setup	24
7.1.5	Additional Setup for MIG welding with aluminium	25
7.1.6	Spool Gun Setup.....	25
7.1.7	Adjusting Settings for MIG Welding in Manual Mode (Program 0).....	26
7.2	Stick (MMA) Welding Operation	27
8	MIG TORCH SPARE PARTS.....	28
9	CARE & MAINTENANCE.....	29
9.1	Keep your Welding Machine in Top Condition	29
9.2	Storing the Welder	29
10	GENERAL GUIDE TO WELDING	30
10.1	Duty Cycle Rating	30
10.2	Choosing a Welding Process – MIG, Stick or TIG?.....	30
10.2.1	The Stick (MMA) Process	30
10.2.2	The TIG Process.....	31



ADVANCEMIG315C

10.2.3	The MIG Process	31
10.3	Joint Preparations.....	32
11	MIG BASIC WELDING GUIDE.....	34
11.1	MIG Basic Welding Techniques.....	34
11.2	Gas Metal Arc Welding (GMAW)	34
11.3	Flux Cored Arc Welding (FCAW)	34
11.4	Position of MIG Torch	35
11.5	Distance from the MIG Torch Nozzle to the Work Piece	35
11.6	Travel Speed	35
11.7	MIG Welding (GMAW) Variables	36
11.7.1	Preselected Variables.....	36
11.7.2	Primary Adjustable Variables	36
11.7.3	Secondary Adjustable Variables.....	36
11.8	Establishing the Arc and Making Weld Beads	38
11.9	MIG Voltage & Wire Speed Settings	38
11.9.1	Setting Wire Speed/Amperage.....	38
11.9.2	Setting Voltage	38
11.9.3	Changing to a different welding wire	38
11.9.4	How to determine correct Wire Speed/Voltage Setting	39
11.10	Suggested Settings for Typical MIG Applications	39
11.11	Welding wire Size Selection	39
11.12	MIG Welding Troubleshooting	40
11.12.1	Porosity Problems	40
11.12.2	Wire Feed Problems.....	41
11.12.3	Weld Quality Problems	42
12	STICK (MMA) BASIC WELDING GUIDE	44
12.1	Size of Electrodes	44
12.2	Storage of Electrodes	44
12.3	Electrode Polarity	44
12.4	Effects of Stick (MMA) Welding on Various Materials.....	44
12.4.1	High Tensile and Alloy Steels.....	44
12.4.2	Manganese Steels	44
12.4.3	Cast Iron	44
12.5	Types of Electrodes	45
12.5.1	MILD STEEL:	45
12.5.2	CAST IRON:.....	45
12.5.3	STAINLESS STEEL:	45



ADVANCEMIG315C

12.6	Suggested Settings for Typical Stick (MMA) Applications	45
12.7	MMA Welding Techniques	46
12.7.1	A Word for Beginners.....	46
12.7.2	The Welder.....	46
12.7.3	Striking the Arc.....	46
12.7.4	Arc Length	47
12.7.5	Rate of Travel	47
12.8	Making Welded Joints	48
12.8.1	Butt Welds.....	48
12.8.2	Fillet Welds.....	49
12.8.3	Vertical Welds	50
12.8.4	Overhead Welds.....	51
12.9	MMA (Stick) Troubleshooting.....	52
13	KNOWLEDGE & RESOURCES.....	54
14	SAFETY	54
14.1	Store and Retain this Manual	54
14.2	Important Safety Information	54
14.3	Welding Operation	54
14.4	Welding Safety Instructions & Warnings.....	56
14.4.1	Personal Safety.....	57
14.4.2	Arc Rays can Burn Eyes and Skin	57
14.4.3	Noise Can Damage Hearing	57
14.4.4	Work Environment Safety	58
14.4.5	Electricity Can Kill.....	58
14.4.6	Fumes And Gases.....	59
15	WARRANTY	60



STRATA
SUPERIOR WELDING PRODUCTS

MIG ARC **315A**
ADVANCEMIG315C



315A
Max Ouput (MIG)



6.0mm
Max Electrode Size



32A 400V
THREE-PHASE



AdvanceMIG315C

AdvanceMIG315C Pack



315A Three-Phase Compact MIG/ARC Inverter Welder

- ✓ **Powerful 315A high duty cycle in lightweight and compact design** - ideal for portable applications
- ✓ **Integrated Heavy Duty Industrial Trolley and Trolley/Storage Option**
- ✓ **4 Roll Geared Industrial Wire Feed Unit** - Powerful and smooth wire feed
- ✓ **Intelligent digital wire feeder with all MIG controls and display on the wire feeder control panel**
- ✓ **Production tested with 550V** - Extreme stress testing in production for rugged reliability.
- ✓ **Industrial IP23 casing with front panel protection** - Resistant to damage, moisture and corrosion
- ✓ **Remote Control Spool Gun Connection** - Effective results welding with soft wires such as Aluminium. Suitable for MIG brazing with bronze wires (Spool Gun optional).
- ✓ **IGBT Module Inverter Technology** - Smooth & stable output, increased reliability, high duty cycle
- ✓ **Digital microprocessor control system** - For superior & dynamic arc characteristics
- ✓ **MIG Waveform (Inductance) Control** - Greater control of the arc for smoother welding results
- ✓ **Adjustable secondary settings such as pre flow, post flow, burn back and soft start** - Greater control for MIG welding operation
- ✓ **2T/4T Trigger Operation with crater control settings**
- ✓ **Dual digital display meters** - For accurate pre-setting and feedback of welding parameters and output
- ✓ **Intelligent Machine Protection System** - Temperature, voltage and current sensors for increased reliability & safety
- ✓ **Generator Friendly** - Designed to work with generator power supply and protect from power surges.
- ✓ **Reversible polarity MIG welding operation** - suitable for gas and gasless welding.
- ✓ **Quick connect inlet gas fitting**

Description	Details
DIMENSIONS (LxWxH)	680 x 240 x 450mm
WEIGHT	26kg
INPUT POWER SUPPLY	400V AC 32A 3 PHASE 50/60Hz
INPUT POWER SUPPLY TOLERANCE	±20%
MAXIMUM INPUT CURRENT	20A
GENERATOR CAPACITY	17kVA
MIG CURRENT OUTPUT	15 - 315A
MIG OUTPUT VOLTAGE	14.8 - 30V
MMA O/C VOLTAGE	70V
MIG DUTY CYCLE	315A@40% 200A@100%
WIRE FEEDING SPEED	2.4 - 18m/min
MMA CURRENT OUTPUT	10 - 315A
MMA DUTY CYCLE	315A@35% 195A@100%

Description	Details
MIG DRIVE ROLLERS	0.6 /0.8/0.9/1.0/1.2mm V Groove 0.8/0.9/1.0/1.2mm Knurled 0.8/1.0/1.2mm U Grooved
MMA ROD SIZE	2.4 - 6.0mm
INSULATION CLASS	IP23
MIG WIRE SPOOL SIZE	D200mm/D300mm 5kg/15kg
POWER EFFICIENCY	85%
POWER FACTOR	0.7
STANDARDS	EN60974-1:2012
WARRANTY	48 Months

Includes:



ADVANCEMIG315C
User guide, specs, videos

LEARN MORE



MIG Inverter Welder Accessories & consumables

○ Standard ● Optional ☆ Common Consumables

ACCESSORY:	ADVANCEMIG315C
Arc Leads	○ AAL3550
Earth Leads	○ AEL3550
MIG Torch	○ MT360-4E
Argon Regulator	○ GR102ARFL
Gas Hose	○ GH08
MIG Starter Kit	● MB36KIT
TIG Torch	● 17374
Spool Gun	● SP240P
DC TIG Starter Kit	● DCKIT
Drive Roller 'V' Groove 0.6 - 0.8mm	○ 17835 (x2)
Drive Roller 'V' Groove 0.9 - 1.0mm	○ 17836 (x2)
Drive Roller 'V' Groove 1.0 - 1.2mm	-
Drive Roller U Groove 0.8 - 1.0mm	● 17841 (x2)
Drive Roller U Groover 1.0 - 1.2mm	-
Drive Roller U Groover 1.2 - 1.6mm	● 17842 (x2)
Drive Roller Knurled 0.8 - 0.9mm	○ 17838 (x2)
Drive Roller Knurled 1.0 - 1.2mm	● 17839 (x2)
Drive Roller Knurled 1.2 - 1.6mm	● 17840 (x2)
MIG Tips (MMT) 0.6 - 1.6mm	☆ 0.6, 0.8, 0.9, 1.0, 1.2, 1.6mm
MIG Shrouds (MCN) 70 = Conical, 71 = Cylindrical	☆ MCN3670, MCN3671
Tip Adaptors (MTA) 81 = M6	☆ MTA3681, MTA3682

Automatic Welding Helmets

- ✓ Variable Shade
- ✓ Complete with batteries ready to go
- ✓ Suitable for automotive DIY and industrial use.

WT180	Variable Shade 9-13
WT350	True Colour, 4 Sensor with grind function
SV3000	True Colour, Shade 5 - 13 + Grind Function (MIG/TIG/MMA/Plasma)
SV4000	Panoramic view with auto darkening side panels. Shade 4 - 13 + Grind Function (MIG/TIG/MMA/Plasma)
DW7000XL	True Colour, with grinding visor. Shade 5 - 13 + PRSL Filtration System (MIG/TIG/MMA/Plasma)

Welding Magnets

WT-WMG03	3" Welding Magnet
WT-WMG05	5" Welding Magnet



Chipping Hammer

- ✓ Heavy duty chipping hammer for the trade

WT-SPCH	Spring Handle Chipping Hammer
----------------	-------------------------------



Mild Steel MIG Wire - ER70S-6

- ✓ Copper coated MIG wire for general purpose welding of mild steel using CO₂ or argon based shielding gases.

MW5KG06	5kg Spool - 0.6mm MIG wire (D200)
MW5KG08	5kg Spool - 0.8mm MIG wire (D200)
MW5KG09	5kg Spool - 0.9mm MIG wire (D200)
D300 MW15KG08S	15kg Spool - 0.8mm MIG wire (D300)
D300 MW15KG09S	15kg Spool - 0.9mm MIG wire (D300)
D300 MW15KG10	15kg Spool - 1.0mm MIG wire (D300)
D300 MW15KG12	15kg Spool - 1.2mm MIG wire (D300)

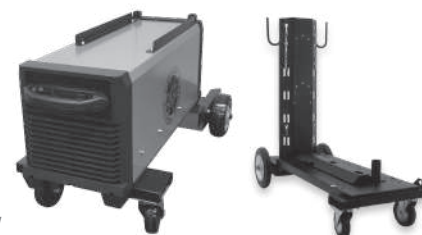

Industrial Storage Trolley

22115	Industrial Storage Unit V2
22108	Integrated Industrial Trolley





ADVANCEMIG315C

3.1 Machine Front

1. Carry Handle
2. Control panel
3. Positive (+) Welding Power Output Connection Socket
4. MIG Torch Euro Connector
5. Spool Gun
6. Negative (-) Welding Power Output Connection Socket

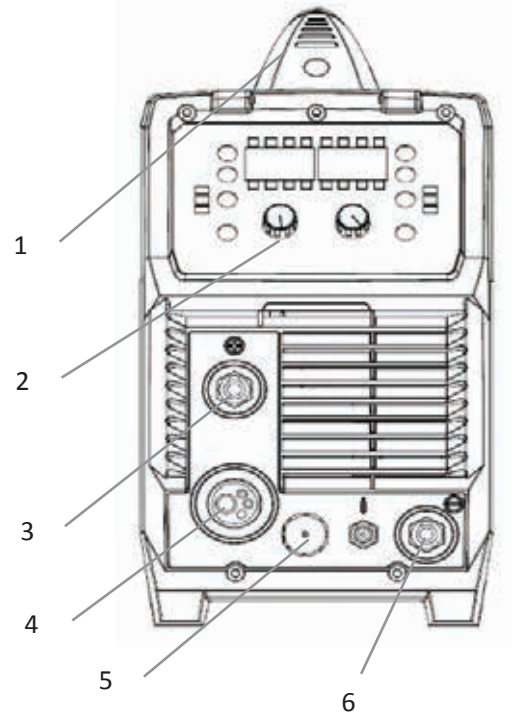
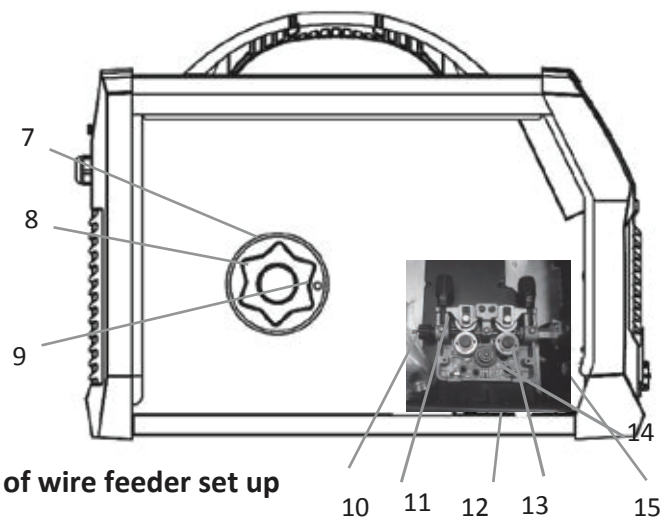

Figure 1

3.2 Machine Side

7. Spool Post
8. Spool Nut
9. Spool Lock Pin
10. Wire Inlet Guide
11. Wire Feed Tension Adjustment Lever
12. Wire Feed Tension Arm/Top Roller
13. Drive Roller
14. Drive Roller Retainer Knob
15. Outlet Wire Guide Tube



Refer Pg 22 & 23 for a more detailed picture of wire feeder set up

Figure 2



ADVANCEMIG315C

3.3 Machine Rear

- 20. Mains Power Switch
- 21. 240V AC Mains Power Input Lead
- 22. Gas Inlet Connection

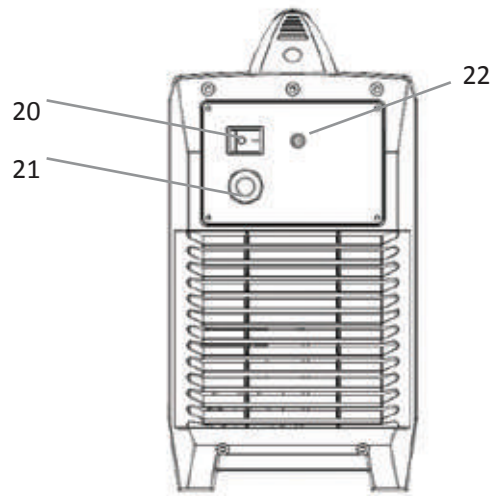

3.4 Control Panel

- 23. Process Indicator Lights
- 24. Process Selection Button (Process)
- 25. Gas Test Button (Test Gas)
- 26. Left Selection Knob (Voltage Dial)
- 27. Right Selection Knob (Wire Speed/Amperage Dial)
- 28. Wire Feed/Load Button (Feed Wire)
- 29. Trigger Mode Selection Button (Trigger)
- 30. Trigger Mode Indicator Lights
- 31. Right LCD Readout
- 32. Left LCD Readout

Figure 3

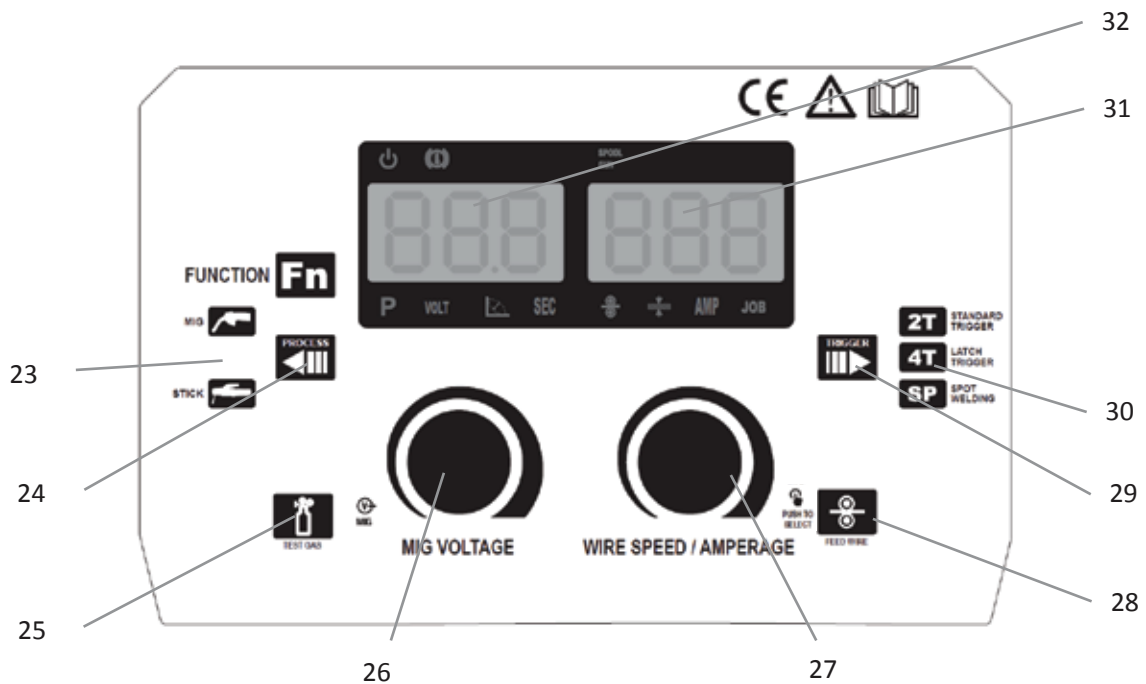

Figure 4



ADVANCEMIG315C

3.5 LCD Readout

- 33. Power On Indicator Light
- 34. Error/Over Temperature Indicator Light
- 35. Spool Gun Mode Indicator Light
- 36. Voltage Setting Indicator Light
- 37. Inductance Setting Indicator Light
- 38. Seconds Setting Indicator Light
- 39. Wire Speed Setting Indicator Light
- 40. Amperage Setting Indicator Light

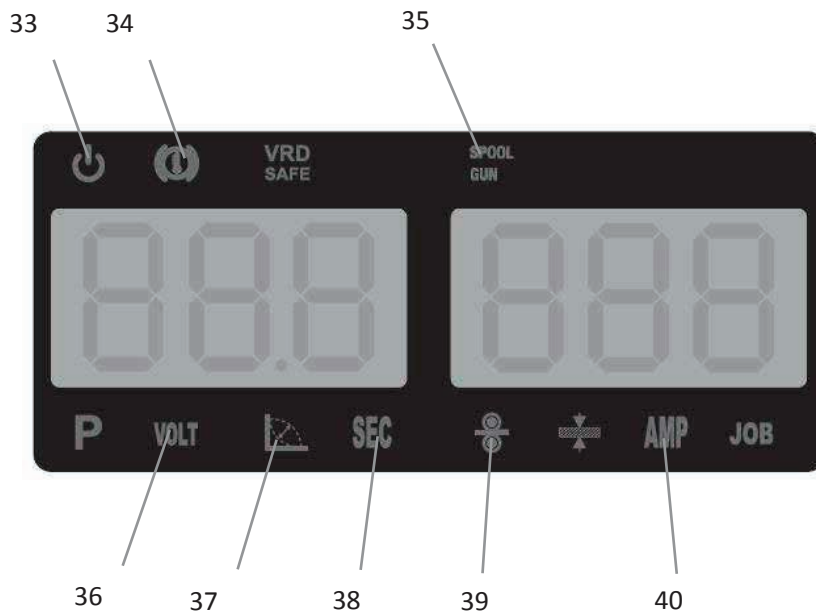

Figure 5

3.6 Symbols chart

	Power On
	Power Off
	Power On Indication
	Fault Indication
	Caution / Hazard
	Read Instruction Manual
	MIG Function
	Stick/MMA Function
	Wire Feed
	Amperage (current) output
	Voltage output
	Variable Inductance
	Increase/Decrease

	Single phase Inverter power source DC
	MIG (GMAW) Function
	Stick/MMA (SMAW) Function
	Power Supply Connection
3 ~	3 Phase
	Direct Current (DC)
-	Negative
+	Positive
Hz	Hertz (cycles/sec)
X	Duty Cycle
A	Amperage (Current)
V	Voltage

Table 2



ADVANCEMIG315C

4.1 Weld Process Selection

1. Press 'Process' button (27) until the desired Welding Process Indicator Light (26) is lit.

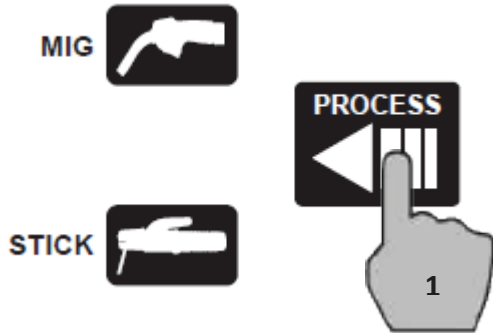

Figure 6

4.1.1 MIG Process:

In Manual MIG mode – before welding, the Left Selection Knob (29) adjusts target voltage output and the Right Selection Knob (30) adjusts Target Wire Speed (m/min). During welding, Left LCD Readout (37) will display actual weld voltage and Right LCD Readout (36) will display actual amperage output.

4.1.2 Stick

Before welding the Left Selection Knob (29) is disabled and the Right Selection Knob (30) adjusts target amperage output. During welding, Left LCD Readout (37) will display actual weld voltage and Right LCD Readout (36) will display actual amperage output.



ADVANCEMIG315C

4.2 Function Selection

1. Press 'Fn' button (25)
2. Rotate Left Selection Knob (29) to select Function (refer to chart below)
3. Rotate Right Selection Knob (30) to adjust parameter for the chosen Function
4. If desired, press 'Fn' (25) button to exit the Function setting

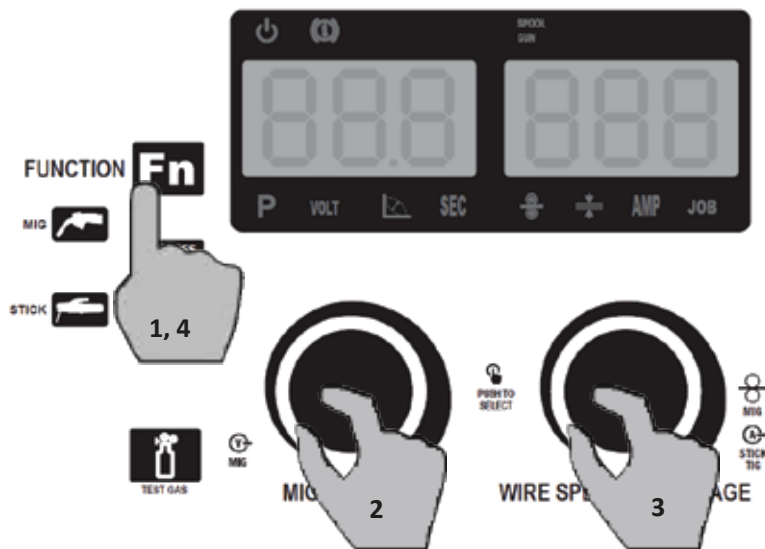

Figure 8

Functions Chart		
Display	Drive Roller	Symbol
MIG MODE		
<i>PrG</i>	Pre-Gas Time (sec)	
<i>PoG</i>	Post-Gas Time (sec)	
<i>SFl</i>	Soft Start Adjustment	
<i>bUb</i>	Burnback Adjustment	
<i>SPt</i>	Spot/Stitch Weld Time (sec)	
<i>GRP</i>	Stitch Weld Gap/Interval Time (sec)	
<i>SPo</i>	Spool Gun (On/Off)	
STICK (MMA) MODE		
<i>Hot</i>	Hot Start Adjustment	
<i>ArL</i>	Arc Force Adjustment	

Table 4



ADVANCEMIG315C

4.2.1 Pre-Gas Time (MIG)

Pre-Gas (or Pre-Flow) setting is adjustable from 0 – 2 seconds. This controls the period shielding gas will flow for when the torch is triggered before the arc starts. This purges the weld zone of atmospheric gas which could contaminate the weld before the weld starts. In most common welding applications pre-gas is not critical and can be set to 0.

4.2.2 Post-Gas Time (MIG)

Post-Gas (or Post-Flow) setting is adjustable from 0 – 5 seconds. This controls the period of time the shielding gas continues to flow after the arc has stopped. This protects the weld area from contamination while it is still hot enough to react with atmospheric gases, after the weld is finished/trigger is released. In most common welding applications post-gas is not critical and can be set to 0.

4.2.3 Soft-Start Adjustment (MIG)

Soft-Start setting is adjustable on a scale 0 – 5. Sometimes known as 'hot start' or 'slow feed'. When a weld is started, the workpiece and the wire will be 'cold' compared to welding temperature. This can cause an uneven and poor start to the weld using the voltage and wire feed speed selected as optimal once the arc is established. This setting slows the wire speed down at the start of the weld which improves the weld starting performance. If you find the wire 'bumping' the workpiece before the arc is fully established try increasing Soft-Start setting.

4.2.4 Burnback Adjustment (MIG)

Burn-back setting is adjustable on a scale 0 – 5. Burnback adjustment controls the short period of time that the wire feed stops and welding current will continue. If the wire feed and current is stopped at exactly the same time, the wire will still be hot and will 'burn' back and stick to the welding tip. If this problem is happening, increasing the burnback adjustment will cause the wire feeder to run for longer after the arc has stopped. If the burnback adjustment is excessive, after a weld has stopped, the operator will be left with excess 'stick out' wire length from the torch tip that will require correcting before starting the next weld.

4.2.5 Spot/Stitch Weld Time (MIG)

This setting will ONLY be accessible when Trigger Mode is set to 'Spot Welding'.

Spot/Stitch Weld Time setting is adjustable from 0 – 5 seconds. This controls the length of time for the weld. When the trigger is pulled the machine will weld for the set time and then stop. This is great for producing very precise weld size or ensuring consistent weld size/length when spot welding, tacking or stitch welding.

4.2.6 Stitch Weld Gap/Interval Time (MIG)

This setting will ONLY be accessible when Trigger Mode is set to 'Spot Welding' (see 4.4 Trigger Mode Selection).

Stitch Weld Gas/Interval Time setting is adjustable from 0 – 5 seconds. This controls the length of time between welds. So when trigger is held on the machine will weld for the 'Spot/Stitch' time then it will stop for the 'Stitch Weld Gap/Interval' time and repeat this until the trigger is released. This is great for producing a very consistent stitch weld or multiple tack welds.

TIP! If you are only doing individual 'Spot' welds (single welds, no repeat) it is suggested to set this Stitch Weld Gap time to maximum and release the trigger before the weld repeats.



ADVANCEMIG315C

4.2.7 Spool Gun On/Off (MIG)

This setting turns activates or deactivates Spool Gun mode. See separate section for full explanation of spool gun operation. The Spool Gun indicator light (40) will be illuminated when Spool Gun Mode is turned on.

4.2.8 Hot Start Adjustment (Stick)

Hot Start setting is adjustable from 0 – 10. Hot start provides extra power when the weld starts to counteract the high resistance of the electrode and workpiece as the arc is started. It makes igniting the electrode easier and prevents it from sticking when cold.

4.2.9 Arc Force Adjustment (Stick)

Arc Force setting is adjustable from 0 – 10. Sometimes called 'Dig' or 'Arc Control'. A Stick welder is designed to produce constant output current (CC). This means with different types of electrode and arc length; the welding voltage varies to keep the current constant. This can cause instability in some welding conditions as Stick welding electrodes will have a minimum voltage they can operate with and still have a stable arc. Arc Force control boosts the welding power if its senses the welding voltage is getting too low. The higher the arc force adjustment, the higher the minimum voltage that the power source will allow. This effect will also cause the welding current to increase. 0 is Arc Force off, 10 is maximum Arc Force. This is practically useful for electrode types that have a higher operating voltage requirement or joint types that require a short arc length such as out of position welds.

4.2.10 Optional VRD Function (Stick)

This function is disabled by default. To have this feature enabled please contact your WeldForce distributor.

When enabled, VRD function reduces the welding machines' open circuit voltage (OCV, or no-load voltage) to a much safer level of approximately 13.5V. OCV is the voltage measured across the positive and negative terminals when welding is not in progress.

The VRD function will turn on full welding power/voltage when the resistance between the electrode and work piece is less than 200 Ohms (i.e. metal to metal contact).

When the VRD function is active, the VRD Active Indicator Light (49) is illuminated.



Figure 9



ADVANCEMIG315C

4.3 Trigger Mode Selection

1. Press 'Trigger' button (32) until the desired Trigger Mode Light is lit

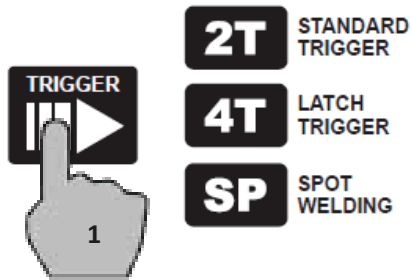

Figure 10

4.3.1 2T (Standard Trigger)

2T is available for MIG & TIG processes.

2T stands for Two Touch or 'Standard Trigger' mode. In this mode the trigger is pulled and held on to start welding, when the trigger is released, the welding stops.

4.3.2 4T (Latch Trigger)

4T is available for MIG & TIG processes.

4T stands for Four Touch or 'Latching' mode. The trigger is pulled once and released to welding and then pulled and released again to stop the welding. This function is useful for longer welds as the trigger is not required to be held on continuously and thus reduced operator fatigue.

4.3.3 SP (Spot/Stitch)

SP is only available for MIG process.

Spot Welding trigger mode is used for Spot, Tacking or Stitch welding. It allows you to set fixed times for welding time and interval between welding and automatically repeats this process until the trigger is released.



ADVANCEMIG315C

4.4 Inductance Control

Inductance setting is adjustable from -5 to +5.

This setting changes the MIG waveform to simulate changing the inductance of the welding circuit. Inductance controls the rate of the current rise and fall as the welding wire contacts the workpiece (known as a short circuit).

More inductance increases the short circuit time and decreases the short circuit frequency rate. This causes a wider and more penetrating arc, often with better edge wetting, useful for thicker weld joints.

Less inductance will create a narrow more focused arc. This effect can also be used to fine tune the arc to produce less spatter. This is often effective on thin materials.

Wire speed, wire size and type, shielding gas will all change the effect that the inductance setting has on the welding arc. Inductance change will have no practical effect on MIG spray transfer process (as opposed to short circuit process).

To adjust inductance (only applied in MIG modes):

1. Press 'Left Selection Knob' (29) down. Inductance Setting Indicator Light (43) should illuminate.
2. Rotate 'Left Selection Knob' (29) to increase or decrease inductance setting. (Normal setting is '0')

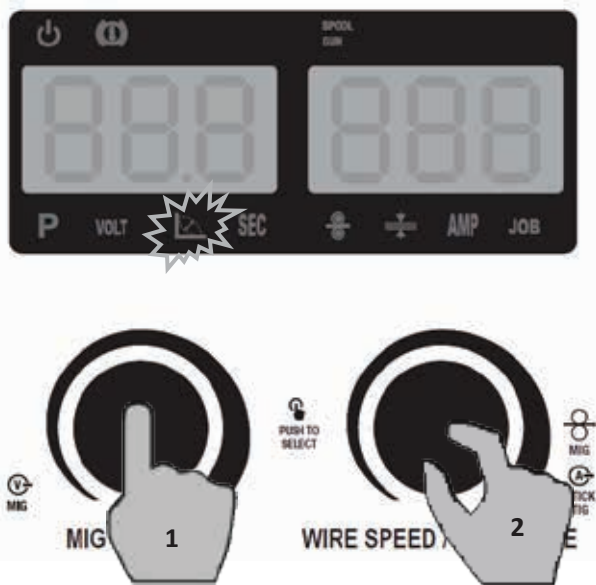

Figure 11

4.5 Test Gas

The 'Test Gas' button (28) works in both MIG and TIG process modes.

This simply opens gas flow (without feeding wire or giving arc voltage) to allow user to check that there is sufficient gas flow coming out of the torch nozzle.



Figure 12



ADVANCEMIG315C

4.6 Feed Wire / Wire Inch

The 'Feed Wire' button (31) only applies to MIG process mode.

This simply activates the MIG wire drive rollers to feed the wire (without wasting gas or giving arc voltage).

This is very useful when loading a new roll of wire and feeding the wire up the torch.



Figure 13

4.7 Error/Over Temperature Indicator Light

Error/Over Temperature Indicator Light (39) illuminates when duty cycle is exceeded and thermal protection is activated. When thermal protection is activated, welding output will be disabled until machines cools sufficiently and overload indicator lamp goes out.

This may also activate if there are electronic circuit failure issues.



Figure 16



ADVANCEMIG315C

5.1 Electrical Connection

The ADVANCE MIG 315 is designed to operate on a 400V 3 PHASE AC.

5.2 Extension Leads

If an extension cord must be used, it should be minimum cable core size 4.0mm². Using extension leads of over 30m is not recommended.

5.3 Generator Use

This machine is designed with generator use in mind and incorporates wide voltage tolerance and intelligent voltage sensing technology to provide maximum protection from power fluctuations that can occur with motor generators.

5.3.1 Generator Size

Generator sizes should be not less than 20kva. An 20kVa 3 PHASE enable full output and duty of this welder.

5.3.2 Generator Quality & Warranty Limitations

Avoid using poor, low quality generators as these have the greatest risk of power spikes etc. A suitable quality generator should have a THD (total harmonic distortion) rating of no more than 6%. Most reputable generator suppliers will be able to specify the THD ratings on their product. Any damage caused by poor quality generator power supply or incorrect use is not covered under warranty.

5.3.3 3 Golden Rules of Generator use

When running an inverter welder off a generator there are 3 **VERY IMPORTANT** Golden Rules that **MUST** be followed:

1. Do **NOT** plug welder into generator until **AFTER** generator has been started up and is running smoothly
2. **UNPLUG** welder from generator **BEFORE** shutting generator down/turning generator off
3. **NEVER** let your generator run out of fuel whilst the welder is plugged in.

Following these Golden Rules will significantly reduce the risk of any damage resulting from generator power supply.



ADVANCEMIG315C

6.1 Location

The machine has electrical components and control circuit boards which may be damaged by excessive moisture, dust and dirt, so a clean and dry operating environment is important for reliable product life.

The enclosure design of this power source meets the requirements of IP23S as outlined in AS60529. This provides adequate protection against solid objects (greater than 12mm), and direct protection from vertical drops. Under no circumstances should the unit be operated or connected in a micro environment that will exceed the stated conditions. For further information please refer to AS 60529.

6.2 Ventilation

Adequate ventilation is required to provide proper cooling for the machine. Ensure that the machine is placed on a stable level surface where clean cool air can easily flow through the unit.



7.1 MIG Welding

WARNING! Before changing the feed roller or wire spool, ensure that the mains power is switched off.

7.1.2 Fitting Wire Spool – 200mm Diameter (5kg) And 15kg

1. Open the wire feeder compartment door.
2. Remove the Spool Nut (9) by threading it anticlockwise.
3. Fit the wire spool to Spool Post (8), ensuring that the wire exits the spool towards the wire feeder from bottom the spool.
4. Set the Spool Brake Tension by adjusting the Spool Tension Nut in the middle of the Spool Post (8). Turn clockwise to increase spool brake tension and anti-clockwise to decrease. The spool brake tension should be set so that the spool can rotate freely, but does not continue to rotate once the wire feed stops. This may need to be adjusted as the wire is used up and the spool weight decreases.

WARNING! Excessive spool brake tension will cause wire feeding issues and affect welding performance as well as premature failure/wear of wire feed components. Insufficient brake tension will cause the spool to 'freewheel' and the welding wire will unravel from the spool (known as a 'birds nest')

5. Replace the Spool Nut (9) by threading it back on the Spool Post (8).
6. Feed the wire from the spool through the Wire Inlet Guide (15) into the wire feeder.

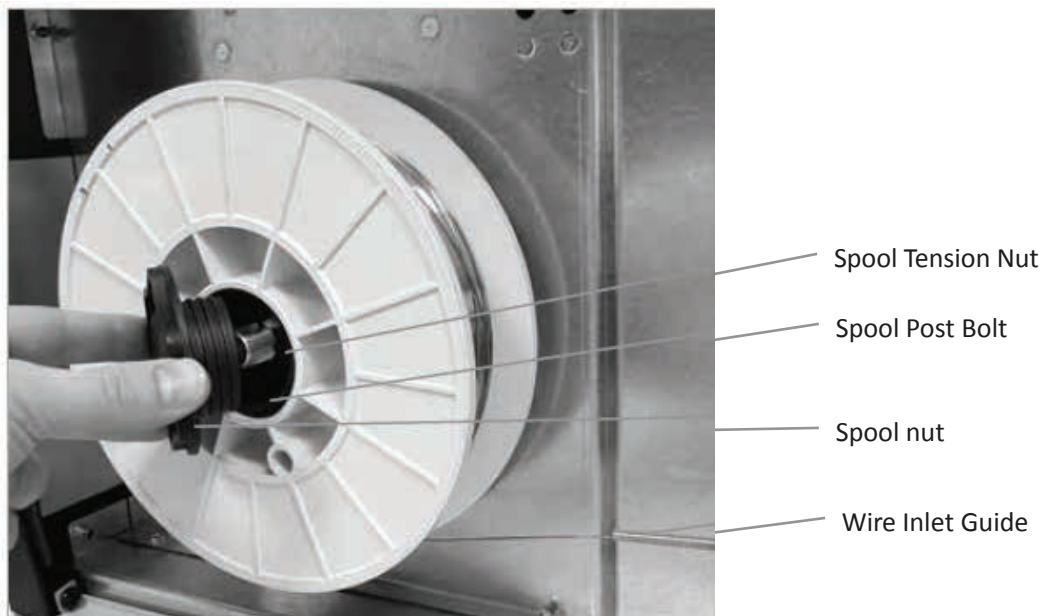

Figure 18



ADVANCEMIG315C

7.1.3 Loading Wire Feeder

1. Release the Wire Feed Tension Arm (17) by pivoting the Wire Feed Tension Adjustment Lever (16) towards you from the vertical 'locked' position.
2. Check the wire Drive Roller (18) groove matches the selected MIG wire type and size. The drive roller will have two different sized grooves; the size of the groove in use is stamped on the side of the drive roller. For flux cored 'soft' wire, such as that used in gasless MIG welding, the drive roller groove has a serrated profile (known as knurled). For solid core 'hard' MIG wire, the drive roller groove used has a 'v' shaped profile. For Aluminum solid core 'soft' MIG wire, the drive roller required has a 'u' shaped groove. If necessary, remove and change the drive roller by unthreading the Drive Roller Retainer Knob (19). Once the correct drive roller (18) is selected and fitted and the Drive Roller Retainer Knob (19) is secured in place, manually feed the wire through the Wire Inlet Guide (15), through the drive roller groove and into the Outlet Wire Guide Tube (20).
3. Ensuring that the wire is correctly seated in the drive roller groove, replace the Wire Feed Tension Arm (17) and lock it into place by pivoting the Wire Feed Tension Adjustment Lever (16) back to the vertical position.
4. Adjusting wire feed tension. This is accomplished by winding the knob on the Wire Feed Tension Adjustment Lever (16). Clockwise will increase tension, anticlockwise will decrease drive tension.

TIP! *Ideal tension is as little as possible, while maintaining a consistent wire feed with no drive roller slippage.*

Check all other causes of excess wire feeding friction causing slippage first, such as; incorrect/worn drive roller, worn/damaged torch consumables, blocked/damaged torch wire guide liner, before increasing wire feed tension. There is a number scale on the the Wire Feed Tension Adjustment Lever (16) to indicate the adjustment position. The higher the number indicated, the higher the tension that is set.

WARNING! *The use of excessive feed tension will cause rapid and premature wear of the drive roller, the support bearing and the drive motor/gearbox.*

5. Connect the MIG Torch to the MIG torch Euro Connector (4) on the front of the machine. Secure by firmly hand tightening the threaded collar on the MIG Torch connector clockwise.
6. Check that the correct matching MIG wire, drive roller (18) and MIG torch tip are fitted.
7. Connect the machine to suitable mains power using the mains input power lead (22). Switch the mains power switch (21) to 'I' (On) to power up the machine.
8. Set welding process selector to 'MIG' (refer to 4.1)
9. You are now ready to feed the wire through the torch. With the wire feeder cover open, press the 'Feed Wire' button (31) to check that the wire is feeding smoothly through the feeder and into the torch.
10. Remove the contact tip from the torch and lay the torch out as straight as possible.
11. Press the 'Feed Wire' button (31) until the wire feeds out through the end of the MIG torch.
12. Replace the tip on the MIG torch and trim off any excess wire.



ADVANCEMIG315C

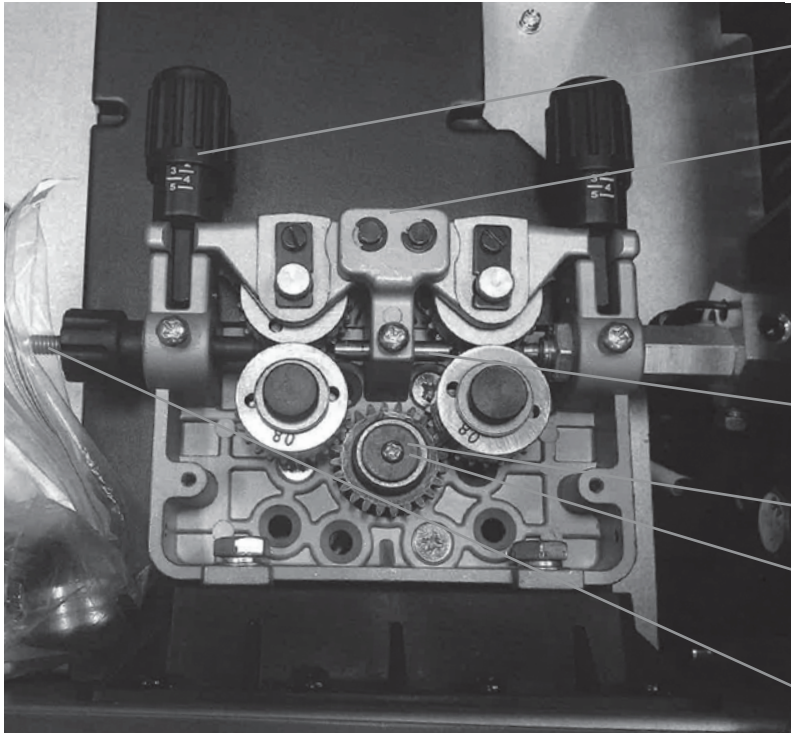

- Wire Feed Tension
- Wire Feed Tension Arm
- Outlet Wire Guide Tube
- Drive Roller
- Drive Roller Retainer Knob
- Wire Inlet

Figure 19



ADVANCEMIG315C

7.1.4 Gas MIG Welding Setup

NOTE: Gas MIG welding will require a gas cylinder. (Argon mix or CO2)

1. Connect the earth cable quick connector to the negative welding power output socket (7).
2. Connect the earth clamp to the work piece. Contact with the work piece must be firm contact with clean, bare metal, with no corrosion, paint or scale at the contact point.
3. Connect the gas regulator to a gas cylinder (not included with machine) and connect the gas hose from the regulator to the gas inlet connection (23) on the rear of the machine. Ensure all hose connections are tight and clamped with the hose clamps provided.
4. Open gas cylinder valve and adjust regulator. Press 'Test Gas' button (28) to initiate flow of gas through the welding torch. Flow should be between 10-25L/min depending on application.



Figure 21

Set up for 0.6 MIG wire.

Because of 0.6 having low column strength 0.6 MIG can cause feed problems.

1. Use a shorter M6 torch - limit to no longer than 3 meters
2. Fit the correct rollers.
3. Fit the correct liner suitable for running 0.6 wire.
4. Use the optional spool gun



ADVANCEMIG315C

7.1.5 Additional Setup for MIG welding with aluminium

Welding with aluminium provides a unique challenge, due to the low column strength and surface friction of the wire. This causes the wire to deform more as it is pushed through the feed mechanism and the torch wire delivery liner, greatly increasing friction. Because good MIG welding results are dependent on a smooth wire feed, certain changes must be made to the wire feed system to minimise friction caused issues.

1. A shorter MIG Torch will minimize friction and issues. If possible limit length to no longer than 3m
2. Replace the liner in the MIG Torch with a special Graphite/Teflon/PVC liner (rather than the conventional steel liner). The Weldclass Universal Graphite liner kit is recommended (P3-CTUL09)
3. Choose the largest diameter wire possible that can but used by your machine for your application. (Ideally 1.0mm or above)
4. Ensure the wire drive system is fitted with the correct size U-groove drive roller to suit the wire being used.
5. Ensure specific Aluminium contact tip to suit chosen wire (or a standard tip in one size oversize, e.g. 1.0mm aluminium wire, use standard 1.2mm contact tip).

TIP! For above reasons, it is quite common for operators to have an extra MIG torch specifically set up for aluminium use, if the machine is used for welding steel as well.

TIP! Another option to overcome the friction issues is using a spool gun, which will give better results and much less frustration than a standard MIG torch when welding aluminium. The EziMig205C is spool gun capable, refer following section for use with a spool gun on the EziMig205C

7.1.6 Spool Gun Setup

NOTE: Spool Gun is an optional extra for the ADVANCE MIG 315

The spool gun is a very useful addition to a MIG welder. It can be used for all types of MIG welding, but it has two primary advantages over a conventional 'push' wire feeder...

The main advantage is that distance that the wire has to travel from the spool to the welding tip is very short, compared with a conventional torch. This greatly reduces the wire feeding friction and improves the wire feed speed smoothness and consistency, thus the welding quality is greatly improved. This is especially so with 'soft' wires such as Aluminium. It is difficult to get Aluminium to feed smoothly in welding machines equipped with standard design wire feeders, even with special torch liners and short torch lengths.

The second advantage is that the gun can allow the use of the small 100mm wire spools at a distance from the power source (This distance is only limited by the length of the spool gun lead). This is advantageous for high cost wire, that is not used commonly such as Stainless Steel or MIG brazing wire. It saves the outlay cost for a much more expensive, larger 200mm spool.

1. Follow above steps for either 'Gasless Welding Setup' or 'Gas MIG Welding Setup' (whichever is relevant) using the spool gun for the torch
2. Connect the spool gun interface plug to the Spool Gun Interface Connection Socket (5).
3. Set welding process selector to 'MIG' (refer to 4.1)
Note: Spool Gun cannot be used with Synergic MIG programs.
4. Set Spool Gun Function setting to 'On' (refer to 4.3)
5. Set the welding voltage adjustment, wire speed control knob and inductance control to the desired positions.
6. You are now ready to weld!



ADVANCEMIG315C

7.1.7 Adjusting Settings for MIG Welding in Manual Mode

1. Follow above steps for either 'Gasless Welding Setup', 'Gas MIG Welding Setup' or 'Spool Gun Setup' (whichever is relevant)
2. Set welding process selector to 'MIG' (refer to 4.1)
3. Set the desired Voltage output using the Left Adjustment Knob (29). Voltage setting will show on Left LCD Readout (37).
4. Set the desired Wire Speed using the Right Adjustment Knob (30). Wire Speed setting will show on Right LCD Readout (36) in meters per minute (m/min).
5. Adjust Inductance if required (refer to 4.5)
6. Adjust special Function settings if required (refer to 4.3)



ADVANCEMIG315C

7.2 Stick (MMA) Welding Operation

1. Connect the earth cable quick connector to the Negative (-) Welding Power Output Socket (7)
2. Connect the earth clamp to the work piece. Contact with the work piece must be firm contact with clean, bare metal, with no corrosion, paint or scale at the contact point.
3. Insert an electrode into the electrode holder and connect the electrode holder and work lead to the Positive (+) Welding Power Output Socket (11).

NOTE: This polarity connection configuration is valid for most GP (General Purpose) MMA electrodes. There are variances to this. If in doubt, check the electrode specifications or consult the electrode manufacturer.

4. Connect the machine to suitable power. Switch the mains power switch (21) to 'on' to power up the machine.
5. Set welding process selector to 'Stick' (refer to 4.1)
6. Select the required output current using the Right Adjustment Knob (30). The Right LCD Readout (36) will display the set amperage output.
7. Adjust special Function settings if required (refer to 4.3)
8. You are now ready to weld!

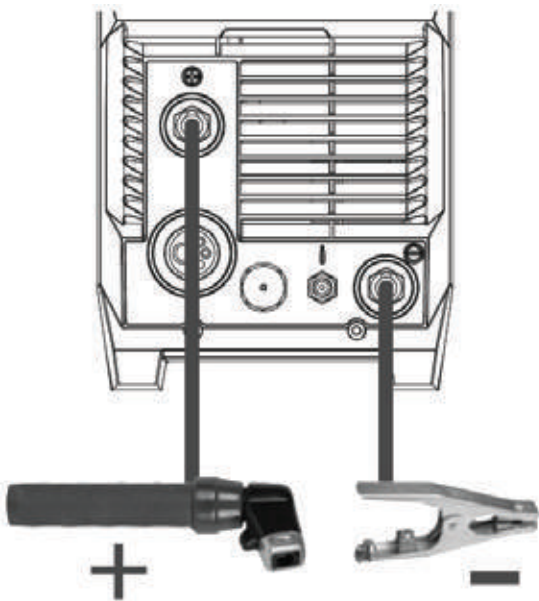

Figure 22



8 MIG TORCH SPARE PARTS



Ref.	Part No.	Description
	MT 360 - 3ER	Complete MT36-3E Torch – 3m
	MT 360 - 4ER	Complete MT36-4E Torch – 4m (Standard)
1	MSN 3654	Neck
2	MD3658W	Diffuser
3	MTA 3681	Tip Holder
4	MMT 2406	Tip 0.6mm
4	MMT 2408	Tip 0.8mm
4	MMT 2409	Tip 0.9mm Pk5
4	MMT 2410	Tip 1.0mm
4	MMT 2410A	Tip 1.0mm Alu Pk5
4	MMT 2412A	Tip 1.2mm Alu/Flux Core Pk5
5	MEN 3671	Nozzle Pk2
6	MSC 2439	Liner – Steel wires - 0.9 To 1.2
6	MTL 2442T	Liner – Aluminium wire

Table 5



ADVANCEMIG315C

9.1 Keep your Welding Machine in Top Condition

The ADVANCEMIG315C does not require any special maintenance, however the user should take care of the machine as follows:

1. Regularly clean the ventilation slots
2. Keep the casing clean
3. Check all cables before use
4. Check electrode holders, work lead/clamps and welding torches before use
5. Replace worn electrode holders and earth clamps, which do not provide a good connection
6. Replace worn torch consumable parts in a timely manner
7. Replace worn wire drive components in a timely manner
8. Use a soft cloth or brush to clean electrical components. Do not use liquid cleaning products, water or especially solvents
9. Do not use compressed air to clean electrical components as this can force dirt and dust further into components, causing electrical short circuits
10. Check for damaged parts

WARNING! Before performing cleaning/maintenance, replacing cables/connections, make sure the welding machine is switched off and disconnected from the power supply.

If damaged, before further use, the welder must be carefully checked by a qualified person to determine that it will operate properly. Check for breakage of parts, mountings and other conditions that may affect its operation.

Have your welder repaired by an expert. An authorised service centre should properly repair a damaged part.

This appliance is manufactured in accordance with relevant safety standards. Only experts must carry out repairing of electrical appliances, otherwise considerable danger for the user may result. Use only genuine replacement parts. Do not use modified or non-genuine parts.

9.2 Storing the Welder

When not in use the welder should be stored in the dry, dust-free and frost-free environment.



10.1 Duty Cycle Rating

WeldForce welding machines are fitted with thermal overload protection which means the machine will cut out when it reaches a certain temperature, to prevent damage to components. The machine will then re-start when it returns to a safe temperature.

Duty cycle is a measure of the percentage of time a machine will operate within a certain time period at a given amperage. For example a duty cycle of 160A @ 25% means that a machine will operate at 160A for 2 ½ minutes in a 10 minute time period. The machine will have to rest for the remaining 7 ½ minutes to enable it to cool down.

The international standard for duty cycle rating is based on an ambient air temperature of 40°C with 50% humidity, over a 10 minute period. In an environment with temperatures exceeding 40°C, the duty cycle will be less than stated. In ambient temperature less than 40°C, duty cycle performance will be higher. There are numerous other factors that can influence actual duty cycle performance.

10.2 Choosing a Welding Process – MIG, Stick or TIG?

10.2.1 The Stick (MMA) Process

10.2.1.1 Description

The acronym MMA (or MMAW) stands for Manual Metal Arc Welding. 'Manual' refers to the fact that the MMA process requires the operator to apply filler metal (in contrast to MIG 'semi-automatic' welding where the machine feeds the filler metal into the weld). 'Metal' refers to the fact that the filler metal itself (the stick electrode) is used to conduct the welding current to the job. MMA welding is commonly known as 'stick-electrode' or 'arc' welding.

10.2.1.2 Process

The MMA process involves the electrode being touched on the job to ignite the arc. The electrode is held in the electrode holder and must be continually replaced as it is consumed. The electrode consists of a metal core, which is the filler metal, covered by a flux coating which shields the weld and prevents it from oxidising. During welding the flux forms into a slag covering the weld which is chipped off after the weld has formed.

10.2.1.3 Advantages

MMA welding offers several advantages over alternative welding processes. Primarily it has a greater capacity than MIG welding, or in other words it can weld heavier materials with the same amperage output. For this reason small, portable inverter welders like the WeldForce machines, have the capacity to weld with up to 3.2mm or 4mm electrodes making it suitable for a vast range of applications without the complication of shielding gas or wire feeding. Moreover, MMA welding is typically more 'forgiving' than MIG or TIG when welding rusty or dirty materials (which makes it ideal for maintenance applications).

10.2.1.4 Limitations

Traditionally, welding thin materials whilst avoiding "blow-through" can be tricky with the MMA process. This being said, however, welding thin materials with a Strata machine will be noticeably easier because the arc is so stable and the output can be very finely adjusted down to very low amps.

10.2.1.5 Materials

MMA welding can be used with a wide variety of electrodes including general purpose, low hydrogen, stainless steel, iron powder, hard facing & cast iron just to name a few.



ADVANCEMIG315C

10.2.2 The TIG Process

10.2.2.1 Description

The acronym TIG stands for Tungsten Inert Gas. Tungsten refers to the type of conductor (a tungsten electrode) that is used to transfer the welding current to the job and create the arc. Inert Gas refers to the fact that the process relies on an inert gas to prevent weld oxidation.

Also referred to as Gas Tungsten Arc Welding (GTAW).

10.2.2.2 Process

In simple terms, TIG welding is probably most similar to oxy flame welding. However, instead of a flame it uses an electrical arc to melt the job and filler metal, and instead of a preheat flame it uses inert gas to prevent weld oxidation. Like oxy flame welding, the filler metal is fed into the weld by hand as required. Due to the fact that the current is not conducted to the job via the filler metal, (as it is in MIG and MMA welding), the arc is much more controllable.

10.2.2.3 Advantages

Very low amperages can be achieved making this process ideal for welding thin materials. Also, due to the independence of the arc and the filler metal application, TIG welding is very controllable and can therefore achieve very high quality welds with excellent appearance. Unlike MIG and MMA welding, TIG welding does not produce spatter so clean up is very minimal. It is typically used where weld appearance is critical (e.g. handrails) or where weld quality is vital (e.g. pressure vessels or pipes).

10.2.2.4 Limitations

Whilst TIG welding is very controllable, it can also be slower and more tedious than MIG or MMA welding and it will generally not operate well on dirty or rusty materials meaning that additional weld preparation is sometimes necessary. It also requires a higher level of skill and experience to achieve a quality result.

10.2.2.5 Materials

This machine incorporates DC TIG function which can be used to weld a variety of materials including mild steels, stainless steels, copper and chrome moly.

Note: TIG welding is often associated with welding of aluminium, however, aluminium TIG welding is only possible with AC/DC TIG welding machines. This machine is DC only and is not designed for TIG welding of aluminium.

10.2.3 The MIG Process

10.2.3.1 Description

The acronym MIG stands for Metal Inert Gas. Metal' refers to the fact that the filler metal itself (the MIG wire) is used to conduct the welding current to the job and create the arc. Inert Gas refers to the fact that the process relies on an inert gas to prevent weld oxidation. The acronym MAG is also often used which stands for Metal Active Gas. MAG is fundamentally the same as MIG except that MAG technically refers to when Carbon Dioxide (CO₂) is used as a shielding gas (instead of an inert gas of argon, helium or a mixed gas with these as a base).

The process is also referred to as Gas Metal Arc Welding (GMAW) when gas is used or Flux-Cored Arc Welding (FCAW) when flux-cored or gasless/self-shielded wire is used.

10.2.3.2 Process

The MIG welding process involves the filler wire being fed through a torch/gun to the job. The filler wire carries the welding current to the job. The weld pool is generally covered by an inert gas supplied from the torch which shields the weld and prevents it from oxidising. However, gasless welding wire can be used without any shielding gas. This gasless wire has a hollow core filled with flux which shields the weld and prevents it from oxidising. During welding this flux forms into a slag covering the weld which is chipped off after the weld has formed.

10.2.3.3 Advantages

MIG welding is both easy and fast. Once weld settings are adjusted, the filler wire is fed automatically into the weld at the correct rate. It does not rely on the operator to feed in filler wire like TIG welding. Also because the filler wire is on a roll it lasts significantly longer than a Stick welding electrode so

there is much less downtime in replacing filler wire. MIG can also weld with thin wires at low amperages achieving great results on thin materials. At the same time, bigger diameter wires and higher amperages can be used to weld thicker materials with good penetration. When a shielding gas is used there is no flux formed on the weld so clean up is minimal.

10.2.3.4 Limitations

MIG welding with shielding gas cannot be done in windy environments. However, in many applications gasless/self-shielding wires are available that don't require gas. MIG traditionally requires a higher level of skill and experience to be able to balance voltage and wire speed settings well to achieve a quality result. However, the Synergic programs on this machine make this this very easy and much more foolproof.

10.2.3.5 Materials

MIG welding can be used with a wide variety of wires including steel, stainless steel, gasless wires, aluminium, silicone bronze & hard facing just to name a few.

10.3 Joint Preparations

In many cases, it will be possible to weld steel sections without any special preparation. For heavier sections and for repair work on castings, etc., it will be necessary to cut or grind an angle between the pieces being joined to ensure proper penetration of the weld metal and to produce sound joints. In general, surfaces being welded should be clean and free of rust, scale, dirt, grease, etc. Slag should be removed from oxy-cut surfaces. Typical joint designs are shown in the following figures.

Open Square Butt Joint

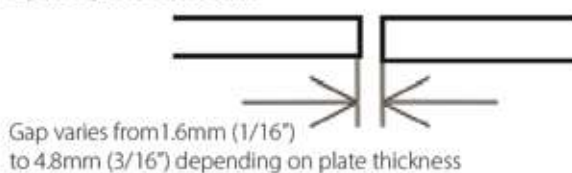

Figure 27

Double Vee Butt Joint

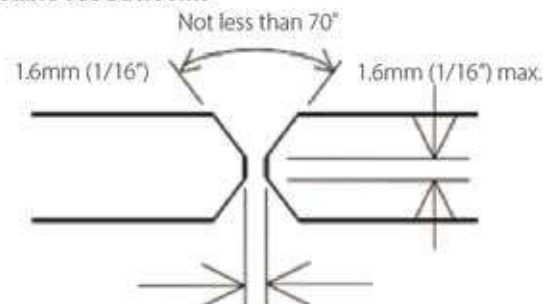

Figure 30

Single Vee Butt Joint

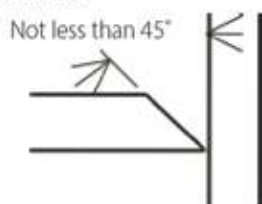

Figure 28

Lap Joint



Figure 31

Single Vee Butt Joint

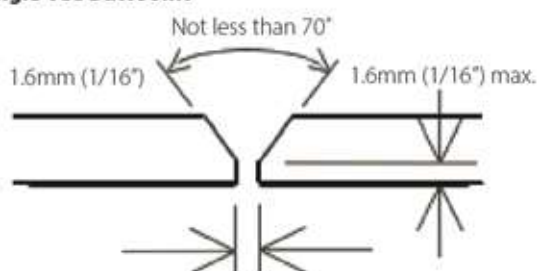

Figure 29

Fillet Joint

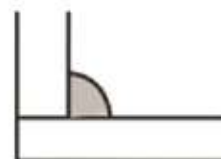

Figure 32



ADVANCEMIG315C

Tee Joints

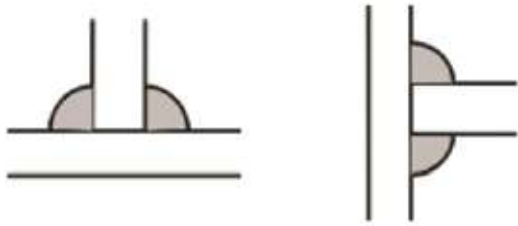

Figure 33

Edge Joint



Figure 34

Corner Weld



Figure 35

Plug Welds



Figure 36

MIG BASIC WELDING GUIDE

11.1 MIG Basic Welding Techniques

Two different welding processes are covered in this section (GMAW and FCAW), with the intention of providing the very basic concepts in MIG welding, where a welding torch is hand held, and the electrode (welding wire) is fed into a weld pool, and the arc is shielded by a gas (GMAW) or flux cored wire (FCAW).

11.2 Gas Metal Arc Welding (GMAW)

This process, also known as MIG welding, CO₂ welding, Micro Wire Welding, short arc welding, dip transfer welding, wire welding etc. It is an electric arc welding process which fuses together the parts to be welded by heating them with an arc between a solid continuous, consumable electrode and the work. Shielding is obtained from an externally supplied welding grade shielding gas. The process is normally applied semi automatically; however the process may be operated automatically and can be machine operated. The process can be used to weld thin and fairly thick steels and some nonferrous metals in all positions.

GMAW Process

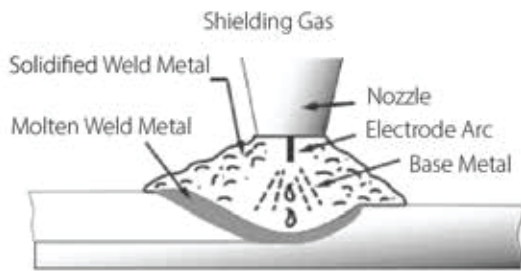

Figure 37

11.3 Flux Cored Arc Welding (FCAW)

This is an electric arc welding process which fuses together the parts to be welded by heating them with an arc between a continuous flux-filled welding wire and the work. Shielding is obtained through decomposition of the flux within the tubular wire. Additional shielding may or may not be obtained from an externally supplied gas or gas mixture. The process is normally applied semi automatically; however the process may be applied automatically or by machine. It is commonly used to weld large diameter wires in the flat and horizontal position and small wire diameters in all positions. The process is used to a lesser degree for welding stainless steel and for overlay work.

FCAW Process

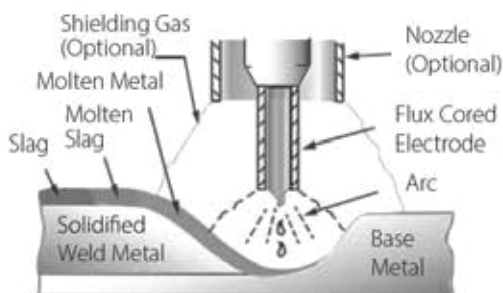

Figure 38



ADVANCEMIG315C

11.4 Position of MIG Torch

The angle of MIG torch to the weld has an effect on the width of the weld. The welding torch should be held at an angle to the weld joint. (See Secondary Adjustable Variables below). Hold the torch so that the welding seam is viewed at all times. Always wear the welding helmet with proper filter lenses and use the proper safety equipment.

CAUTION! Do not pull the welding torch back when the arc is established. This will create excessive wire extension (stick-out) and make a very poor weld.

The welding wire is not energized until the torch trigger switch is depressed. The wire may therefore be placed on the seam or joint prior to lowering the helmet.

Position of MIG Torch

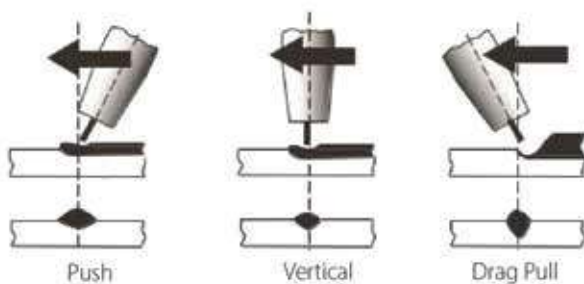

Figure 39

11.5 Distance from the MIG Torch Nozzle to the Work Piece

The welding wire stick out from the MIG Torch nozzle should be between 10mm to 20mm. This distance may vary depending on the type of joint and type of wire that is being welded. Generally solid wire is about 10mm and flux-cored/gasless wire about 15-20mm.

11.6 Travel Speed

The speed at which the molten pool travels influences the width of the weld and penetration of the welding run.

11.7 MIG Welding (GMAW) Variables

Most of the welding done by all processes is on carbon steel. The items below describe the welding variables in short-arc welding of 0.6mm to 6mm mild sheet or plate. The applied techniques and end results in the MIG process are controlled by these variables.

11.7.1 Preselected Variables

Preselected variables depend upon the type of material being welded, the thickness of the material, the welding position, the deposition rate and the mechanical properties.

These variables are:

1. Type of welding wire
2. Size of welding wire
3. Type of shielding gas
4. Gas flow rate

11.7.2 Primary Adjustable Variables

These control the process after preselected variables have been found. They control the penetration, bead width, bead height, arc stability, deposition rate and weld soundness.

These variables are:

1. Arc Voltage
2. Welding current (wire feed speed)
3. Travel speed

11.7.3 Secondary Adjustable Variables

These variables cause changes in primary adjustable variables which in turn cause the desired change in the bead formation. They are:

1. **Stick-Out:** This is the distance between the end of the contact tube (tip) and the end of the welding wire). Maintain at about 10mm stick-out for solid wire and 15-20mm for gasless wire.

Electrode Stick-Out

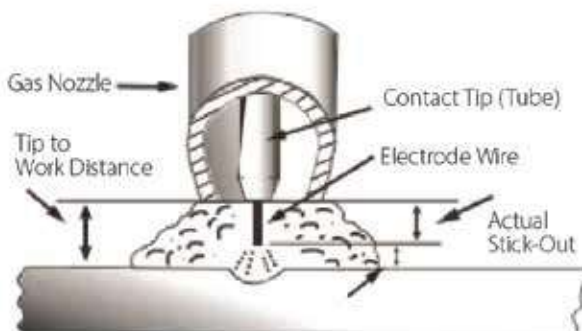

Figure 40

2. **Wire Feed Speed:** Increase in wire feed speed increases weld current/amperage. Decrease in wire feed speed decreases weld current.

- 3. Nozzle Angle:** This refers to the position of the welding torch in relation to the joint. The transverse angle is usually one half the included angle between plates forming the joint. The longitudinal angle is the angle between the centre line of the welding torch and a line perpendicular to the axis of the weld. The longitudinal angle is generally called the Nozzle Angle and can be either trailing (pulling) or leading (pushing). Whether the operator is left handed or right handed has to be considered to realize the effects of each angle in relation to the direction of travel.

Transverse & Longitudinal Nozzle Axes

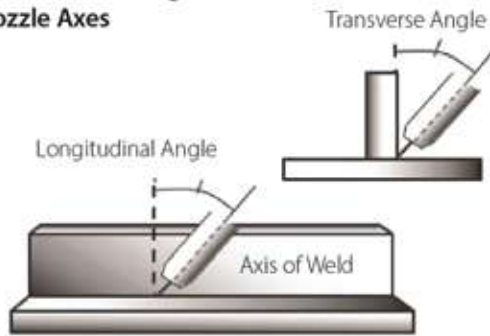

Figure 41

Nozzle Angle, Right Handed Operator

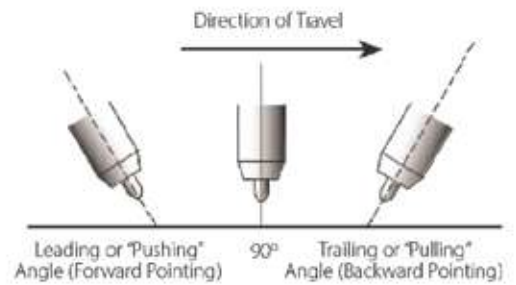

Figure 42

Horizontal Butt Weld

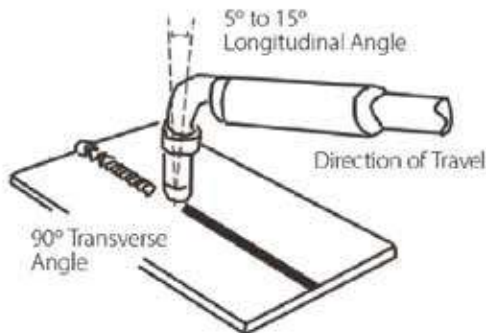

Figure 43

Vertical Fillet Welds

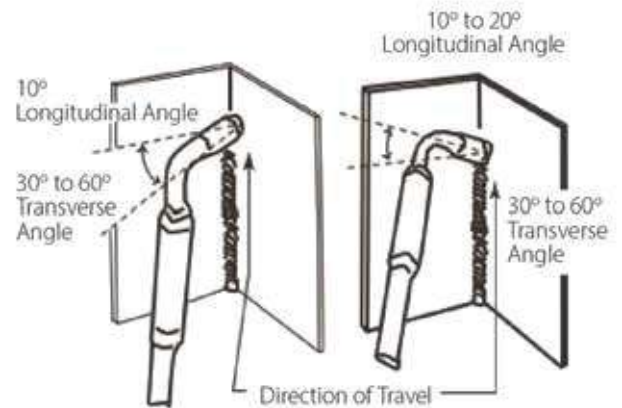

Figure 45

Horizontal Fillet Weld

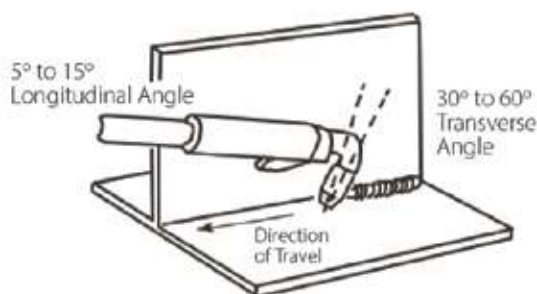

Figure 44

Overhead Fillet Weld

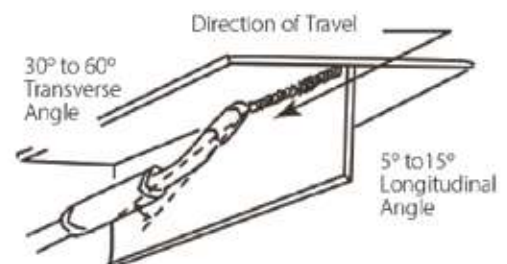

Figure 46



11.8 Establishing the Arc and Making Weld Beads

Before attempting to weld on a finished piece of work, it is recommended that practice welds be made on a sample metal of the same material as that of the finished piece. The easiest welding procedure for the beginner to experiment with MIG welding is the flat position. The equipment is capable of flat, vertical and overhead positions. For practicing MIG welding, secure some pieces of 1.6mm or 2.0mm mild steel plate (150 x 150mm). Use 0.9mm flux cored gasless wire or a solid wire with shielding gas.

11.9 MIG Voltage & Wire Speed Settings

Manual MIG welding setting requires some practice by the operator, as the machine has two control settings that have to balance. These are the Wire Speed control and the Welding Voltage control.

Voltage is essentially the power in the welding arc that sets the heat. The wire speed feed simply controls the rate at which the welding wire is fed into the weld pool. For any voltage position setting, there will be a specific corresponding 'sweet spot' in the wire feeding speed that will give the smoothest and most stable welding arc. The correct wire feeding speed for a given voltage setting is affected by welding wire type and size, shielding gas, welding material and joint type.

The recommended process for setting a MIG (in Manual mode) is:

1. Set the welding voltage as desired
2. Slowly adjust the wire speed until the arc is smooth and stable.
3. When reaching this point, if the penetration/ heat input is too much/ not enough, adjust the voltage setting and repeat the process.
4. If not able to achieve a smooth and stable arc with the desired heat input for the weld, it is likely that a change in wire size and/or shielding gas type is required (assuming all other factors are correct).

11.9.1 Setting Wire Speed/Amperage

The welding current (amperage) is determined by the Wire Speed control. Increased Wire Speed will increase the current and result in a shorter arc. Less Wire Speed will reduce the current and lengthen the arc.

11.9.2 Setting Voltage

Increasing the welding voltage hardly alters the current level, but lengthens the arc. By decreasing the voltage, a shorter arc is obtained with a little change in current level.

11.9.3 Changing to a different welding wire

When changing to a different welding wire diameter, different control settings are required. A thinner welding wire needs more Current (Wire Speed) to achieve the same current level. A satisfactory weld cannot be obtained if the Current (Wire Speed) and Voltage settings are not adjusted to suit the welding wire diameter and the dimensions of the work piece.



ADVANCEMIG315C

11.9.4 How to determine correct Wire Speed/Voltage Setting

If the Current/Amperage (Wire Speed) is too high for the welding voltage, “sticking” will occur as the wire dips into the molten pool and does not melt. Welding in these conditions normally produces a poor weld due to lack of fusion.

If, however, the welding voltage is too high, large drops will form on the end of the wire, causing spatter. The correct setting of voltage and Current (Wire Speed) can be seen in the shape of the weld deposit and heard by a smooth regular arc sound.

11.10 Suggested Settings for Typical MIG Applications

Material	Wire Type	Shielding Gas	Wire Size	Weld Position	Amperage Range	Voltage Range
Mild Steel	Solid Mild Steel (E70S-6)	Argon + CO ² Mix	0.6mm	All	50 – 80	18 – 20
			0.8mm	All	60 – 220	16 – 22
			0.9mm	All	120 – 350	15 – 23
	Gasless Flux-cored Mild Steel (E71T-11)	Not required	0.8mm	Horizontal	90 – 150	14 – 16
				Vertical & Overhead	60 – 125	10 – 12
			0.9mm	Horizontal	80 – 200	12 – 17
				Vertical & Overhead	70 – 150	12 – 15
			1.2mm	Horizontal	160 – 220	16 – 18
Vertical & Overhead	120 – 180	16 – 18				
Stainless Steel	Stainless Steel 316L	Argon or Mix	0.8mm	All	60 – 125	17 – 22
			0.9mm	All	75 – 160	17 – 22
Aluminium	Aluminium (5356)	Argon	1.0mm	All	170 – 200	19 – 21

Table 10

These settings are a guide only. Actual settings required will depend on plate thickness, operator technique, environment, etc.

11.11 Welding wire Size Selection

The choice of Welding wire size and shielding gas used depends on the following:

1. Thickness of the metal to be welded
2. Type of joint
3. Capacity of the wire feed unit and power source
4. The amount of penetration required
5. The deposition rate required
6. The bead profile desired
7. The position of welding
8. Cost of the wire
9. Environment (can shielding gas be used or not?)



11.12 MIG Welding Troubleshooting

The general approach to fix MIG welding problems is to start at the wire spool then work through to the MIG torch. There are two main areas where problems occur with MIG: Porosity and Inconsistent wire feed.

11.12.1 Porosity Problems

When there is a gas problem the result is usually porosity within the weld metal. Porosity always stems from some contaminant within the molten weld pool which is in the process of escaping during solidification of the molten metal.

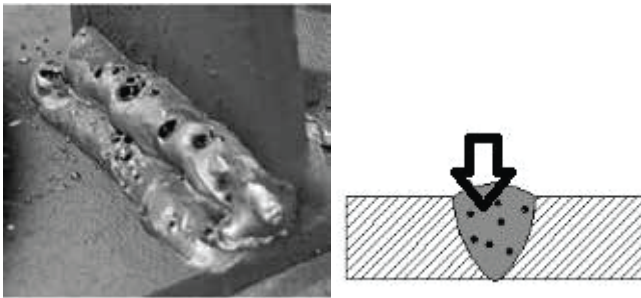

Figure 47

Contaminants range from no gas around the welding arc to dirt on the workpiece surface. Porosity can be reduced by checking the following points.

Troubleshooting - Porosity	
Fault	Cause
Shielding gas cylinder contents and gas regulator	Ensure that the shielding gas cylinder is not empty and the gas regulator is correctly adjusted to at least 15 litres per minute
Gas leaks	Check for gas leaks between the regulator/cylinder connection and in the gas hose to the Power Source.
Internal gas hose in the Power Source	Ensure the hose from the solenoid valve to the torch adaptor has not fractured and that it is connected to the torch adaptor. This should only be done by qualified technician.
Welding in a windy environment	Shield the weld area from the wind or increase the gas flow or use gasless welding wire
Welding dirty, oily, painted, oxidized or greasy plate	Clean contaminates off the work piece.
Distance between the MIG torch nozzle and the work piece	Keep the distance between the MIG torch nozzle and the work piece to a minimum.
Maintain the MIG torch in good working order.	Ensure that the gas holes are not blocked in the tip holder and gas is exiting out of the torch nozzle.
	Do not restrict gas flow by allowing spatter to build up inside the torch nozzle.
	Check that the MIG torch O-rings are not damaged on the Euro connector.

Table 11

WARNING! Disengage the feed roll when testing for gas flow by ear or use the 'Gas Test' button



11.12.2 Wire Feed Problems

TOP TIPS - Wire Jam Troubleshooting

- If wire jam occurs when the torch becomes hot, this is often because the heat causes the wire and the top to expand (which shrinks the hole in the tip). Using a slightly oversize tip can prevent this – eg: for 0.9mm wire, use a 1.0mm tip.
- Do NOT over-tighten the drive roll tension – this will accelerate wear if the drive system, distort the wire & will cause further wire feed problems.

Table 12





Wire feeding problems can be reduced by checking the following points.
The most common faults are marked with *:

Troubleshooting – Wire Feed	
Fault	Cause
Feed roller driven by motor in the cabinet slipping	Wire spool brake is too tight.
Wire spool unwound and tangled.	Wire spool brake is too loose.
Worn or incorrect feed roller size	Use a feed roller matched to the size you are welding.
	Replace feed roller if worn.
Wire rubbed against the misaligned guides affecting the wire feed.	Misalignment of inlet/outlet guides.
* Liner blocked with swarf (Replace liner)	Increased amounts of swarf are produced by the wire passing through the feed roller when excessive pressure is applied to the pressure roller adjuster.
	Swarf can also be produced by the wire passing through an incorrect feed roller groove shape or size.
	Swarf is fed into the conduit liner where it accumulates thus reducing wire feed.
* Incorrect or worn contact tip	The contact tip transfers the weld current to the electrode wire. If the hole in the contact tip is too large then arcing may occur inside the contact tip resulting in the wire jamming in the contact tip.
	When using soft wire such as aluminum it may become jammed in the contact tip due to expansion of the wire when heated. A contact tip designed for soft wires should be used.
Poor work lead contact to work piece.	If the work lead has a poor electrical contact to the work piece then the connection point will heat up and results in reduction of power at the arc.
Bent liner (Replace liner)	This will cause friction between the wire and the liner this reducing wire feed.

Table 13

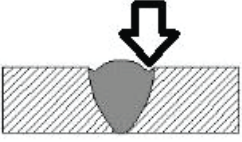
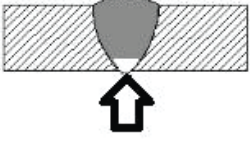
11.12.3 Weld Quality Problems

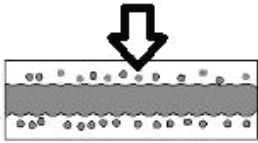
Other weld problems can be reduced by checking the following points.

Troubleshooting – MIG Weld Quality		
Fault	Cause	Remedy
Undercut  <i>Figure 48</i>	Welding arc voltage too high	Decrease voltage or increase the wire feed speed.
	Incorrect torch angle	Adjust angle.
	Excessive heat input	Increase the torch travel speed and/or decrease welding current by decreasing the voltage or decreasing the wire feed speed.
Lack of penetration  <i>Figure 49</i>	Welding current too low.	Increase welding current by increasing wire feed speed and increasing voltage.
	Joint preparation too narrow or gap too tight.	Increase joint angle or gap
	Shielding gas incorrect.	Change to a gas which give higher penetration
Lack of fusion  <i>Figure 50</i>	Voltage too low	Increase voltage
Excessive spatter  <i>Figure 51</i>	Voltage too high	Decrease voltage or increase the Current (Wire Speed) control
	Voltage too low.	Increase the voltage or decrease Current (Wire Speed)
Irregular weld shape	Incorrect voltage and current settings. Convex, voltage too low. Concave, voltage too high.	Adjust voltage and current by adjusting the voltage control and the Current (Wire Speed) control
	Wire is wandering.	Replace contact tip.
	Incorrect shielding gas.	Check shielding gas.
	Insufficient or excessive heat input.	Adjust the Current (Wire Speed) control or the voltage control.
Weld cracking  <i>Figure 52</i>	Weld bead is too small.	Decrease travel speed.
	Weld penetration narrow and deep.	Reduce current and voltage and increase MIG torch travel speed or select a lower penetration shielding gas.
	Excessive weld stresses.	Increase weld metal strength or revise design.
	Excessive voltage.	Decrease voltage.
	Cooling rate too fast.	Slow the cooling rate by preheating part to be welded or cool slowly.



ADVANCEMIG315C

Troubleshooting – MIG Weld Quality		
Fault	Cause	Remedy
Cold weld puddle	Loose welding cable connection.	Check all welding cable connections
	Low power supply voltage.	Contact supply authority
Arc does not have a crisp sound that short arc exhibits when the wire feed speed and voltage are adjusted correctly	The MIG torch has been connected to the wrong voltage polarity on the front panel.	Connect the MIG torch to the positive (+) welding terminal for solid wires and negative (-) welding terminal for gasless wires. Refer to the wire manufacturer for the correct polarity.

Table 14



STICK (MMA) BASIC WELDING GUIDE

12.1 Size of Electrodes

The electrode size is determined by the thickness of metals being joined and can also be governed by the type of welding machine available. Small welding machines will only provide current (amperage) to run smaller sized electrodes. For thin sections, it is necessary to use smaller electrodes otherwise the arc may burn holes through the job. A little practice will soon establish the most suitable electrode for a given application.

12.2 Storage of Electrodes

Always store electrodes in a dry place and in their original containers. If electrodes have been exposed to moisture or moist air then they will need to be dried out using an electrode drying oven.

12.3 Electrode Polarity

Electrodes are generally connected to the electrode holder with the electrode holder connected positive polarity. This can change with different manufacturers.

The work lead is connected to the negative polarity and is connected to the work piece. If in doubt consult the electrode data sheet.

12.4 Effects of Stick (MMA) Welding on Various Materials

12.4.1 High Tensile and Alloy Steels

The two most prominent effects of welding these steels are the formation of a hardened zone in the weld area, and, if suitable precautions are not taken, the occurrence in this zone of under-bead cracks. Hardened zone and under-bead cracks in the weld area may be reduced by using the correct electrodes, preheating, using higher current settings, using larger electrodes sizes, short runs for larger electrode deposits or tempering in a furnace.

12.4.2 Manganese Steels

The effect on manganese steel of slow cooling from high temperatures causes embrittlement. For this reason it is absolutely essential to keep manganese steel cool during welding by quenching after each weld or skip welding to distribute the heat.

12.4.3 Cast Iron

Most types of cast iron, except white iron, are weldable. White iron, because of its extreme brittleness, generally cracks when attempts are made to weld it. Trouble may also be experienced when welding white-heart malleable, due to the porosity caused by gas held in this type of iron.



12.5 Types of Electrodes

Arc Welding electrodes are classified into a number of groups depending on their applications. There are a great number of electrodes used for specialised industrial purposes which are not of particular interest for everyday general work. These include some low hydrogen types for high tensile steel, cellulose types for welding large diameter pipes, etc. The range of electrodes dealt with in this publication will cover the vast majority of applications likely to be encountered; are all easy to use.

12.5.1 MILD STEEL:

- 1. General Purpose "GP" E6013:** This all-position electrode is used for maintenance and fabrication. Works well on mild steel, galvanized steel, sheet metal, steel tube and RHS. Its soft arc has minimal spatter, moderate penetration and an easy-to-clean slag. Tolerant to dirty / rusty steel & poor fit up. This is the most common type of electrode used for Stick welding.
- 2. Hydrogen Controlled E7016:** A "low-hydrogen" electrode commonly used for mild or high strength steel, where the joint requires higher strength than regular "GP" electrodes, such as highly restrained joints or components subject to higher load stress. Also used as a buffer layer prior to hard facing. All-Positional (except for vertical down), easy striking & smooth running, with low spatter & easy slag removal.

12.5.2 CAST IRON:

- 1. Cast Iron Ni-CI (NCI):** Suitable for joining all cast irons (Suitable for mehanite, alloy and malleable cast iron) except white cast iron. Weld positions : flat, horizontal.

12.5.3 STAINLESS STEEL:

- 1. Stainless Steel 316L:** Used for welding common 300 series stainless steels such as 301, 302, 304, 304L and 316L. All welding positions, excluding vertical down. Very Smooth Running and Easy to use.
- 2. Universal 312:** Weld-all style electrodes for welding almost any steel or stainless-steel, including dissimilar metals. Weld metal is very crack resistant. Commonly used for repair and maintenance welding of unknown steels. All welding positions excluding vertical down.

12.6 Suggested Settings for Typical Stick (MMA) Applications

Material	Electrode Type	Electrode Size	Amperage Range
Mild Steel	General Purpose (E6013)	2.6mm	60 – 100
		3.2mm	100 – 140
		4.0mm	140 – 190
Mild Steel	Hydrogen Controlled (High Strength) (E7016)	2.5mm	60 – 110
		3.2mm	90 – 140
		4.0mm	130 – 190
Stainless Steel	Stainless Steel 316L	2.6mm	40 – 70
		3.2mm	100 – 150
		4.0mm	135 – 180

Table 15

These settings are a guide only. Actual settings required will depend on plate thickness, operator technique, environment, etc.

12.7 MMA Welding Techniques

12.7.1 A Word for Beginners

For those who have not yet done any welding, the simplest way to commence is to run beads on a piece of scrap plate. Use mild steel plate about 6.0mm thick and a 3.2mm electrode.

Clean any paint, loose scale or grease off the plate and set it firmly on the work bench so that welding can be carried out in the down hand position. Make sure that the Work Lead/Clamp is making good electrical contact with the work, either directly or through the work table. For light gauge material, always clamp the work lead directly to the job, otherwise a poor circuit will probably result.

12.7.2 The Welder

Place yourself in a comfortable position before beginning to weld. Get a seat of suitable height and do as much work as possible sitting down. Don't hold your body tense. A taut attitude of mind and a tensed body will soon make you feel tired. Relax and you will find that the job becomes much easier. You can add much to your peace of mind by wearing a leather apron and gauntlets. You won't be worrying then about being burnt or sparks setting alight to your clothes.

Place the work so that the direction of welding is across, rather than to or from, your body. The electrode holder lead should be clear of any obstruction so that you can move your arm freely along as the electrode burns down. If the lead is slung over your shoulder, it allows greater freedom of movement and takes a lot of weight off your hand. Be sure the insulation on your cable and electrode holder is not faulty; otherwise you are risking an electric shock.

12.7.3 Striking the Arc

Practice this on a piece of scrap plate before going on to more exacting work.

You may at first experience difficulty due to the tip of the electrode "sticking" to the work piece. This is caused by making too heavy a contact with the work and failing to withdraw the electrode quickly enough. A low amperage will accentuate it. This freezing on of the tip may be overcome by scratching the electrode along the plate surface in the same way as a match is struck.

Another difficulty you may meet is the tendency, after the arc is struck, to withdraw the electrode so far that the arc is broken again. A little practice will soon remedy both of these faults.

Striking an Arc

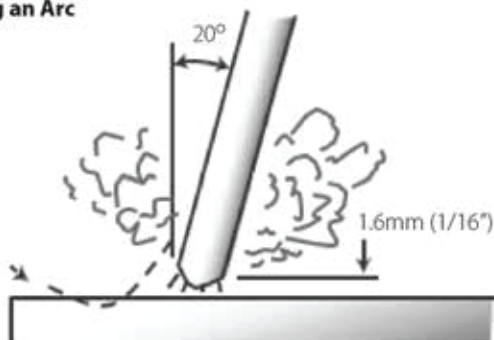

Figure 53



ADVANCEMIG315C

12.7.4 Arc Length

As soon as the arc is established, maintain a 1.6mm to 3.2mm gap between the burning electrode end and the parent metal. Draw the electrode slowly along as it melts down. The securing of an arc length necessary to produce a neat weld soon becomes almost automatic. You will find that a long arc produces more heat.

A very long arc produces a crackling or spluttering noise and the weld metal comes across in large, irregular blobs. The weld bead is flattened and spatter increases. A short arc is essential if a high quality weld is to be obtained although if it is too short there is the danger of it being blanketed by slag and the electrode tip being solidified in. If this should happen, give the electrode a quick twist back over the weld to detach it.

12.7.5 Rate of Travel

After the arc is struck, your next concern is to maintain it, and this requires moving the electrode tip towards the molten pool at the same rate as it is melting away. At the same time, the electrode has to move along the plate to form a bead.

The electrode is directed at the weld pool at about 20° from the vertical. The rate of travel has to be adjusted so that a well-formed bead is produced.

If the travel is too fast, the bead will be narrow and strung out and may even be broken up into individual globules. If the travel is too slow, the weld metal piles up and the bead will be too large.

12.8 Making Welded Joints

Having attained some skill in the handling of an electrode, you will be ready to go on to make up welded joints.

12.8.1 Butt Welds

Set up two plates with their edges parallel, as shown in Figure 54, allowing 1.6mm to 2.4mm gap between them and tack weld at both ends. This is to prevent contraction stresses from the cooling weld metal pulling the plates out of alignment.

Plates thicker than 6.0mm should have their mating edges beveled to form a 70° to 90° included angle. This allows full penetration of the weld metal to the root. Using a 3.2mm Weldclass 12V Stick electrode at 100 amps, deposit a run of weld metal on the bottom of the joint.

Do not weave the electrode, but maintain a steady rate of travel along the joint sufficient to produce a well-formed bead. At first you may notice a tendency for undercut to form, but keeping the arc length short, the angle of the electrode at about 20° from vertical, and the rate of travel not too fast, will help eliminate this.

The electrode needs to be moved along fast enough to prevent the slag pool from getting ahead of the arc. To complete the joint in thin plate, turn the job over, clean the slag out of the back and deposit a similar weld.

Heavy plate will require several runs to complete the joint. After completing the first run, chip the slag out and clean the weld with a wire brush. It is important to do this to prevent slag being trapped by the second run. Subsequent runs are then deposited using either a weave technique or single beads laid down in the sequence shown in Figure 55. The width of weave should not be more than three times the core wire diameter of the electrode.

When the joint is completely filled, the back is either machined, ground or gouged out to remove slag which may be trapped in the root, and to prepare a suitable joint for depositing the backing run. If a backing bar is used, it is not usually necessary to remove this, since it serves a similar purpose to the backing run in securing proper fusion at the root of the weld.

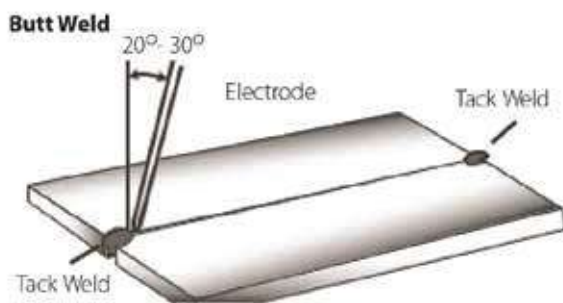

Figure 54

Weld Build Up Sequence

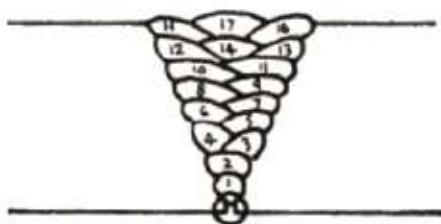

Figure 55

12.8.2 Fillet Welds

These are welds of approximately triangular cross-section made by depositing metal in the corner of two faces meeting at right angles. Refer Figure 56 and Figure 57.

A piece of angle iron is a suitable specimen with which to begin, or two lengths of strip steel may be tacked together at right angles. Using a 3.2mm 6013 Stick electrode at 100amps, position angle iron with one leg horizontal and the other vertical. This is known as a horizontal-vertical (HV) fillet.

Strike the arc and immediately bring the electrode to a position perpendicular to the line of the fillet and about 45° from the vertical. Some electrodes require being sloped about 20° away from the perpendicular position to prevent slag from running ahead of the weld. Refer to Figure 56.

Do not attempt to build up much larger than 6.4mm width with a 3.2mm electrode, otherwise the weld metal tends to sag towards the base, and undercut forms on the vertical leg. Multi-runs can be made as shown in Figure below. Weaving in HV fillet welds is undesirable.

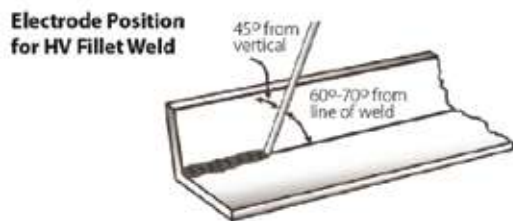

Figure 56



Figure 57

12.8.3 Vertical Welds

12.8.3.1 Vertical Up

Tack weld a three feet length of angle iron to your work bench in an upright position. Use a 3.2mm 6013 Stick electrode and set the current at 100 amps. Make yourself comfortable on a seat in front of the job and strike the arc in the corner of the fillet. The electrode needs to be about 10° from the horizontal to enable a good bead to be deposited.

Refer Figure 58.

Single Run Vertical Fillet Weld

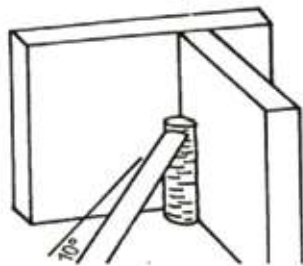

Figure 58

Use a short arc, and do not attempt to weave on the first run. When the first run has been completed deslag the weld deposit and begin the second run at the bottom. This time a slight weaving motion is necessary to cover the first run and obtain good fusion at the edges.

At the completion of each side motion, pause for a moment to allow weld metal to build up at the edges, otherwise undercut will form and too much metal will accumulate in the centre of the weld. Figure 59 illustrates multi-run technique and Figure 60 shows the effects of pausing at the edge of weave and of weaving too rapidly.

Multi Run Vertical Fillet Weld

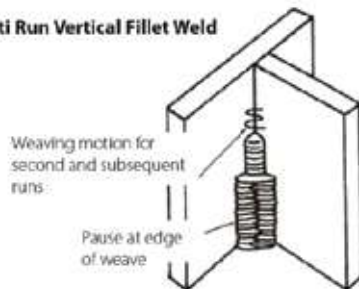

Figure 59

Examples of Vertical Fillet Welds

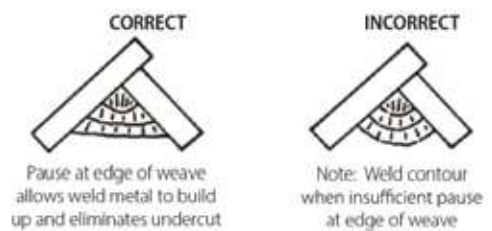

Figure 60

12.8.3.2 Vertical Down

The 6013 Stick electrode makes welding in this position particularly easy. Use a 3.2mm 6013 electrode at 100 amps. The tip of the electrode is held in light contact with the work and the speed of downward travel is regulated so that the tip of the electrode just keeps ahead of the slag. The electrode should point upwards at an angle of about 45°.

12.8.4 Overhead Welds

Apart from the rather awkward position necessary, overhead welding is not much more difficult than down hand welding. Set up a specimen for overhead welding by first tacking a length of angle iron at right angles to another piece of waste pipe. Then tack this to the work bench or hold in a vice so that the specimen is positioned in the overhead position as shown in the sketch.

The electrode is held at 45° to the horizontal and tilted 10° in the line of travel (Figure 61). The tip of the electrode may be touched lightly on the metal, which helps to give a steady run. A weave technique is not advisable for overhead fillet welds.

Use a 3.2mm 6013 Stick electrode at 100 amps, and deposit the first run by simply drawing the electrode along at a steady rate. You will notice that the weld deposit is rather convex, due to the effect of gravity before the metal freezes.

Overhead Fillet Weld

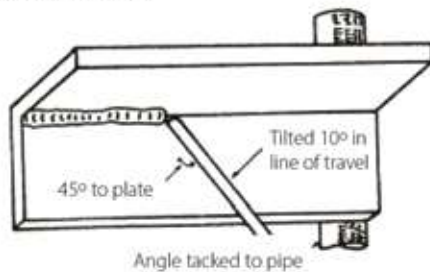
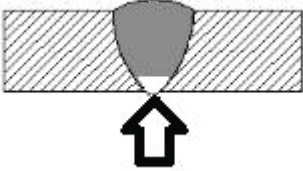
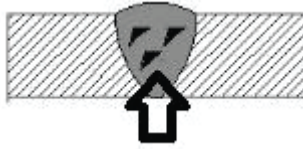
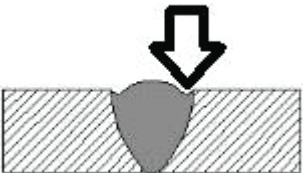

Figure 61

12.9 MMA (Stick) Troubleshooting

Fault	Cause	Remedy
<p>A gap is left by failure of the weld metal to fill the root of the weld.</p>  <p>Figure 62</p>	Welding current too low.	Increase welding current.
	Electrode too large for joint.	Use smaller diameter electrode.
	Insufficient gap.	Allow wider gap.
<p>Non-metallic particles are trapped in the weld metal.</p>  <p>Figure 63</p>	Non-metallic particles may be trapped in undercut from previous run.	If a bad undercut is present clean slag out and cover with a run from a smaller gauge electrode.
	Joint preparation too restricted.	Allow for adequate penetration and room for cleaning out the slag.
	Irregular deposits allow slag to be trapped.	If very bad, chip or grind out irregularities.
	Lack of penetrations with slag trapped beneath weld bead.	Use smaller electrode with sufficient current to give adequate penetrations. Use suitable tools to remove all slag from comers.
	Rust or mill scale or preventing full fusion.	Clean joint before welding.
	Wrong electrode for position in which welding is done.	Use electrodes designed for position in which welding is done, otherwise proper control of slag is difficult.
<p>A groove has been formed in the base metal adjacent to the top of a weld and has not been filled by the weld metal (undercut).</p>  <p>Figure 64</p>	Welding current is too high.	Reduce welding current.
	Welding arc is too long.	Reduce the length of the welding arc.
	Angle of the electrode is incorrect.	Electrode should not be inclined less than 45° to the vertical face.
	Joint preparation does not allow correct electrode angle.	Allow more room for joint for manipulation of the electrode.
	Electrode too large for joint.	Use smaller gauge electrode.
	Insufficient deposit time at edge of weave.	Pause for a moment at edge of weave to allow weld metal build-up.
	Power source is set for MIG (GMAW) welding.	Set power source to STICK (MMA) mode.



Fault	Cause	Remedy
Portions of the weld run do not fuse to the surface of the metal or edge of the joint.  Figure 65	Small electrodes used on heavy cold plate.	Use larger electrodes and preheat the plate.
	Welding current is too low.	Increase welding current.
	Wrong electrode angle.	Adjust angle so the welding arc is directed more into the base metal.
	Travel speed of electrode is too high.	Reduce travel speed of electrode.
	Scale or dirt on joint surface.	Clean surface before welding.
Gas pockets or voids in weld metal (porosity)  Figure 66	High levels of Sulphur in steel.	Use an electrode that is designed for high Sulphur steels.
	Electrodes are damp.	Dry electrodes before use.
	Welding current is too high.	Reduce welding current.
	Surface impurities such as oil, grease, paint, etc.	Clean joint before welding.
	Welding in a windy environment.	Shield the weld area from the wind.
	Electrode damaged i.e. flux coating incomplete.	Discard damaged electrodes and only use electrodes with a complete flux coating.
Crack occurring in weld metal soon after solidification commences  Figure 67	Rigidity of joint.	Redesign to relieve weld joint of severe or use crack resistance electrodes.
	Insufficient throat thickness.	Travel slightly slower to allow greater build up in throat.
	Weld current is too high.	Decrease welding current.

Table 16

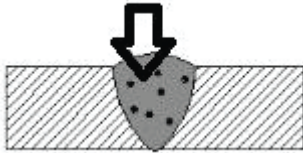

13 KNOWLEDGE & RESOURCES

14

14.1 Store and Retain this Manual

Retain this manual for the safety warnings and precautions, assembly, operating, inspection, maintenance and cleaning procedures. Write the product's serial number into the NOTES section at the rear, and keep this manual and the receipt in a safe and dry place for future reference.

14.2 Important Safety Information

Failure to follow the warnings and instructions may result in electric shock, fire, serious injury and/or death. Save all warnings and instructions for future reference.

This is the safety alert symbol to alert you to potential personal injury hazards:



Obey all safety messages that follow this symbol to avoid possible injury or death.



DANGER! indicates a hazardous situation which, if not avoided, will result in death or serious injury.



WARNING! indicates a hazardous situation which, if not avoided, could result in death or serious injury.



CAUTION, used with the safety alert symbol, indicates a hazardous situation which, if not avoided, could result in minor or moderate injury.

NOTE, used to address practices not related to personal injury.

CAUTION, without the safety alert symbol, is used to address practices not related to personal injury.

14.3 Welding Operation

1. **Maintain labels and nameplates on the welder.** These carry important information. If unreadable or missing, contact Strata for a replacement.
2. **Avoid unintentional starting.** Make sure the welder is setup correctly and you are prepared to begin work before turning on the welder.
3. **Unplug before performing maintenance.** Always unplug the welder from its electrical outlet before performing any inspection, maintenance, or cleaning procedures.
4. **Never leave the welder unattended while energised.** Turn power off before leaving the welder unattended.



ADVANCEMIG315C

5. **Do not touch live electrical parts.** Wear dry, insulating gloves. Do not touch the electrode or the conductor tong with bare hands. Do not wear wet or damaged gloves.
6. **Protect yourself from electric shock.** Do not use the welder outdoors. Insulate yourself from the work piece and the ground. Use non-flammable, dry insulating material if possible, or use dry rubber mats, dry wood or plywood, or other dry insulating material large enough to cover the area of contact with the work or the ground.
7. **Avoid inhaling fume.** Some fume created by welding contain chemicals known to cause cancer, birth defects or other harm. Your risk from these exposures varies, depending on how often you do this type of work. To reduce your exposure to these chemicals, work in a well-ventilated area, and work with approved safety equipment, such as dust masks that are specially designed to filter out microscopic particles.
8. **People with pacemakers should consult their physician(s) before using this machine.**



WARNING! *Electromagnetic fields in close proximity to a heart pacemaker could cause interference, or failure of the pacemaker. The use of a Welder is NOT RECOMMENDED for pacemaker wearers. Consult your doctor.*

9. **Ensure that the unit is placed on a stable location before use.**



WARNING! *If this unit falls while plugged in, severe injury, electric shock, or fire may result.*

10. **Transportation Methods.** Lift unit with the handles provided, or use a handcart or similar device of adequate capacity. If using a fork lift vehicle, secure the unit to a skid before transporting.



CAUTION! *Disconnect input power conductors from de-energized supply line before moving the welding power source.*

11. **Exercise good work practices.** The warnings, precautions, and instructions discussed in this instruction manual cannot cover all possible conditions and situations that may occur. It must be understood by the operator that common sense and caution are factors which cannot be built into this product, but must be considered by the operator.
12. **Do not use this machine for pipe thawing.** This machine was not designed for pipe thawing and will be a significant electrical & heat hazard if attempt is made to use for thawing pipe.



ADVANCEMIG315C

14.4 Welding Safety Instructions & Warnings



WARNING! Protect yourself and others from possible serious injury or death. Keep children away. Read the operating/Instruction manual before installing, operating or servicing this equipment. Have all installation, operation, maintenance, and repair work performed by qualified people.

If an operator does not strictly observe all safety rules and take precautionary actions, welding products and welding processes can cause serious injury or death, or damage to other equipment or property.

Safe practices have developed from past experience in the use of welding and cutting. These practices must be learned through study and training before using this equipment. Some of these practices apply to equipment connected to power lines; other practices apply to engine driven equipment. Anyone not having extensive training in welding and cutting practices should not attempt to weld.

Safe practices are outlined in the Australian Standard AS 1674.2 entitled: Safety in Welding and European Standard EN60974-1 entitled: Safety in welding and allied processes.



WARNING! Only use safety equipment that has been approved by an appropriate standards agency. Unapproved safety equipment may not provide adequate protection. Eye and breathing protection must be AS/NZS compliant for the specific hazards in the work area.



DANGER! Always wear AS/NZS compliant safety glasses and full face shield fitted with appropriate filter shade number. (Refer Filter Table on page 17.)



CAUTION! Heavy-duty work gloves, non-skid safety shoes and hearing protection used for appropriate conditions will reduce personal injuries.



CAUTION! Have the equipment serviced by a qualified repair person using identical replacement parts. This will ensure that the safety of the power tool is maintained.



ADVANCEMIG315C

14.4.1 Personal Safety



CAUTION! *Keep the work area well lit. Make sure there is adequate space surrounding the work area. Always keep the work area free of obstructions, grease, oil, trash, and other debris. Do not use equipment in areas near flammable chemicals, dust, and vapours. Do not use this product in a damp or wet location.*

1. **Stay alert, watch what you are doing and use common sense when operating equipment.** Do not use a tool while you are tired or under the influence of drugs, alcohol or medication. A moment of distraction when operating equipment may result in serious personal injury.
2. **Do not overreach.** Keep proper footing and balance at all times. This enables better control of the power tool in unexpected situations.

14.4.2 Arc Rays can Burn Eyes and Skin



CAUTION! *Arc rays from the welding process produce intense heat and strong ultraviolet rays that can burn eyes and skin.*

1. Use a Welding Helmet or Welding Face Shield fitted with a proper shade filter (refer AS 60974-1, AS/NZS 1337.1 and AS/NZS 1338.1 Safety Standards) to protect your face and eyes when welding or watching. (See Filter Table on Page17).
2. Wear approved safety glasses. Side shields are recommended.
3. Use protective screens or barriers to protect others from flash and glare; warn others not to watch the arc.
4. Wear protective clothing made from durable, flame-resistant material (wool and leather) and foot safety protection.
5. Never wear contact lenses while welding.

14.4.3 Noise Can Damage Hearing



CAUTION! *Noise from some processes can damage hearing. Use AS/NZS compliant ear plugs or ear muffs if the noise level is high.*



ADVANCEMIG315C

14.4.4 Work Environment Safety



DANGER! Remove any combustible material from the work area.

1. When possible, move the work to a location well away from combustible materials. If relocation is not possible, protect the combustibles with a cover made of fire resistant material.
2. Remove or make safe all combustible materials for a radius of 10 metres around the work area. Use a fire resistant material to cover or block all doorways, windows, cracks, and other openings.
3. Enclose the work area with portable fire resistant screens. Protect combustible walls, ceilings, floors, etc., from sparks and heat with fire resistant covers.
4. If working on a metal wall, ceiling, etc., prevent ignition of combustibles on the other side by moving the combustibles to a safe location. If relocation of combustibles is not possible, designate someone to serve as a fire watch, equipped with a fire extinguisher, during the welding process and well after the welding is completed.
5. Do not weld or cut on materials having a combustible coating or combustible internal structure, as in walls or ceilings, without an approved method for eliminating the hazard.
6. After welding, make a thorough examination for evidence of fire. Be aware that visible smoke or flame may not be present for some time after the fire has started. Do not weld or cut in atmospheres containing dangerously reactive or flammable gases, vapours, liquids, and dust. Provide adequate ventilation in work areas to prevent accumulation of flammable gases, vapours, and dust.
7. Do not apply heat to a container that has held an unknown substance or a combustible material whose contents, when heated, can produce flammable or explosive vapours. Clean and purge containers before applying heat. Vent closed containers, including castings, before preheating, welding, or cutting.

14.4.5 Electricity Can Kill



DANGER! Touching live electrical parts can cause fatal shocks or severe burns.
The electrode and work circuit is electrically live whenever the output is on.

The input power circuit and machine internal circuits are also live when power is on. In semiautomatic or automatic wire welding, the wire, wire reel, drive roll housing, and all metal parts touching the welding wire are electrically live. Incorrectly installed or improperly grounded equipment is a hazard.

1. Do not touch live electrical parts.
2. Wear dry, hole-free insulating gloves and body protection.
3. Insulate yourself from the work and the ground using dry insulating mats or covers.
4. Disconnect input power before installing or servicing this equipment. Lock input power, disconnect switch open, or remove line fuses so power cannot be turned on accidentally.



ADVANCEMIG315C

5. Properly install and ground this equipment according to national, state, and local codes.
6. Turn off all equipment when not in use. Disconnect power to equipment if it will be left unattended or out of service.
7. Use fully insulated electrode holders. Never dip the holder in water to cool it or lay it down on the ground or the work surface. Do not touch holders connected to two welding machines at the same time or touch other people with the holder or electrode.
8. Do not use worn, damaged, undersized, or poorly spliced cables.
9. Do not wrap cables around your body.
10. Connect work piece to a good electrical ground.
11. Do not touch the electrode while in contact with the work (ground) circuit.
12. Use only well-maintained equipment. Repair or replace damaged parts as soon as practical.
13. In confined spaces or damp locations, do not use a welder with AC output unless equipped with a voltage reducer.

Arc rays from the welding process produce intense heat and strong ultraviolet rays that can burn eyes and skin. Use the following table to select the appropriate shade number for a Welding Helmet or Welding Face Shield.

Recommended Protection Fillers For Electric Welding		
Welding Process / Application	Approximate Range of Welding Current in Amps	Minimum Shade Number of Filter Lens
Stick (MMA)	Up to 100	8
	100 to 200	10
MIG (other than Aluminum and Stainless Steel)	Up to 150	10
	150 to 250	11
MIG of Aluminum and Stainless Steel	Up to 250	12
MIG Flux-Cored Arc Welding (FCAW) – with or without Shielding Gas	Up to 300	10

Table 24

14.4.6 Fumes And Gases



WARNING! *Welding produces fumes and gases. Breathing these fumes and gases can be hazardous to your health.*

1. Keep your head out of the fumes. Do not breathe the fumes.
2. If inside, ventilate the area and/or use an exhaust at the arc to remove welding fumes and gases.
3. If ventilation is poor, use an approved supplied-air respirator (PAPR).
4. Read the Safety Data Sheets (SDS) and the manufacturer's instruction for the metals, consumables, coatings, and cleaners.
5. Work in a confined space only if it is well ventilated, or while wearing an air-supplied respirator. Shielding gases used for welding can displace air causing injury or death. Be sure the breathing air is safe.



ADVANCEMIG315C

Warranty

As part of an on-going commitment to excellence in product support, Euroquip offers a comprehensive product warranty program.

Registered warranty period for the ADVANCEMIG315C:

Commercial Use: 48 Months

Domestic Use: 48 Months

Warranty covers failure caused by manufacturing and material defects in the product, during the warranty period specified. The warranty period begins when the product is purchased by the end user. Warranty is not transferrable and is only claimable by the original purchaser.

Warranty does not cover parts that are subject to wear and tear from usage.

Warranty covers failure of a product caused by defective materials and/or manufacturing for the period given and the usage specified by Euroquip. The warranty period begins when the product is purchased by the end user. Warranty is not transferrable and is only claimable by the original purchaser.

Warranty also does not cover failure caused by the untimely replacement or service of the above wearing parts. Evidence must be provided that the product has been maintained and serviced suitably for a claim to be considered under warranty.

Failure caused by incorrect operation of the product, lack of proper care and maintenance of the product, external damage, external circumstances such as contaminated fuel or poor water supply, modifications to the product, attempted repair/ service by a party other than an Approved Service Agent, is not covered under warranty.

Warranty does not cover pre delivery service and adjustment, or failure that may occur as a result of lack of/ incorrect pre delivery service and adjustment.

Warranty does not cover any incidental, indirect or consequential loss, damage or expense that may result from any defect, failure or malfunction of a product.

Should any issue be found to be a combination of a warranty failure and a non-warranty issue, the repair cost component to rectify and repair the non-warranty failure is the customers' full responsibility.

The decision that an issue with a product qualifies as a warranty claim is made at the sole jurisdiction of Euroquip.

No costs incurred will be considered under warranty if repairs are carried out by a party other than a Euroquip Approved Service Agent, unless with prior consent in writing from Euroquip.

It is the responsibility of the purchaser to deliver a product under warranty to the nearest relevant service agent or product reseller. Warranty does not cover call outs, mileage and freight costs.

If a product is repaired under warranty, parts and labour required for the repair will be supplied at no charge. Warranty assessment and repair will be scheduled and executed according to the normal work flow at the service location and depending on the availability of suitable replacement parts.

This warranty policy is an additional benefit and does not affect the legal rights of any end user, reseller or service agent.



ADVANCEMIG315C



Congratulations on your new STRATA product. We are proud to have you as our customer and will strive to provide you with the best service and reliability in the industry. This product is backed by our extensive warranty. To locate your nearest distributor or service agency visit www.strata.co.nz, or email us at CustomerService@euroquip.co.nz

www.strata.co.nz